

FIBER OPTIC CABLE ASSEMBLY MANUFACTURABILITY AND DESIGN GUIDE

A. INTRODUCTION

The purpose of this document is to define the standards and guidelines that should be followed in order to fabricate a harsh environment fiber optic cable assembly. Environmental requirements such as temperature, humidity, vibration, shock, etc., should be communicated to the cable assembly manufacturer for compliance considerations and adjustments. Most materials identified in this guide are qualified in a military or harsh environment. Deviations from these standards and guidelines should be discussed with the manufacturer.

B. DIMENSIONING AND TOLERANCING

1. Standard Cable Assembly Length Tolerances

Cable Length (feet)	Tolerance
< 5	*min +/-1.5 inches
> 5 to 50	+5% / -0
> 50 to 100	+4% / -0
>100 to 250	+3% / -0
>250 to 500	+2% / -0
>500	+1% / -0

Table 1

NOTES:

- Tolerances can be rounded up to the nearest inch or foot for simplicity when cables are long.
- Tolerance requirements less than 1.5 inches should be discussed with the manufacturer.

2. Length of Overall Assembly

Unless otherwise specified, the final overall length of a cable assembly shall be measured or determined from end to end as illustrated below.

a) Single terminus/connector to single terminus/connector

Ferrule tip to ferrule tip.



Figure-1

b) Multi-channel connector (plug/receptacle) to pig-tail (fan-out)

Front face of the insert cap on multi-channel connector to ferrule tips of individual connectors.

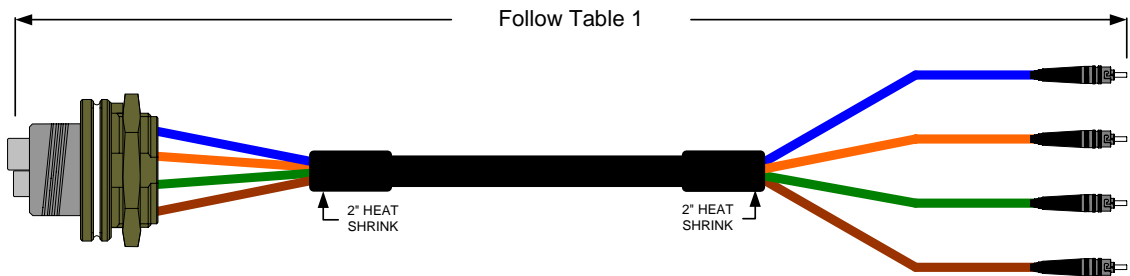

Figure-2

c) Multi-channel connector (plug/receptacle) to multi-channel connector (plug/receptacle)

Front face of the insert cap on one multi-channel connector to the other.

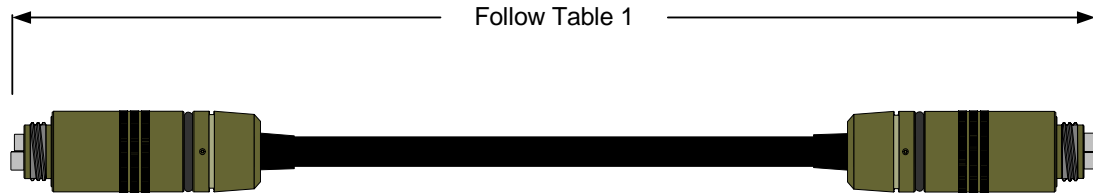

Figure-3

3. Length of Breakouts (fan-out)

- Length: 12 inches is typical but it can be specified.
- Tolerance: +2.0 inches / -0.0 inch is typical. If the pig-tail length exceeds the typical length, use the tolerances in Table 1.

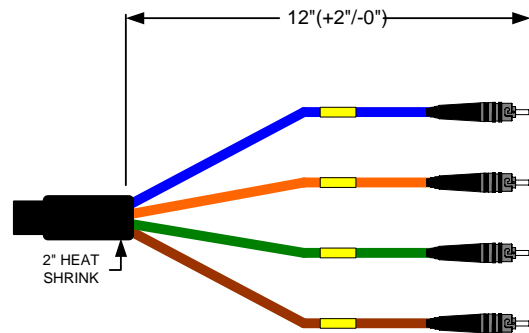

Figure-4

4. Length of Breakout Behind Plug/Receptacle

- Length: 6 inches is standard.
- Tolerance: +/- 1.0 inch is typical.
- Dimension lines shall be placed at the edge of the heat shrink.

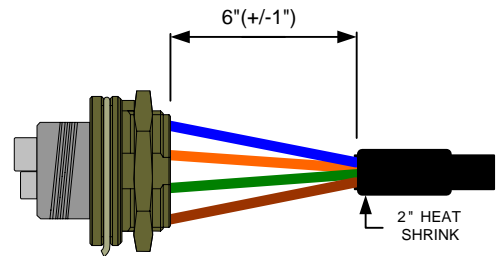

Figure-5

C. LABELING REQUIREMENTS

1. Types

- a) Heat shrink tubing: Polyolephyn, MIL standard M23053. Standard colors are WHITE and YELLOW.

NOTE: Part number of M23053 heat shrink tubing shall be M23053/5-XXX-Y

XXX = size/diameter

Y = color (4 = yellow, 9 = white)

- b) Label wrap: Clear plastic sheet with adhesive backing. This type is used for label repair/replacement. The most common are Brady brand DAT-38-292 or Panduit LJSL8-PO3-1.
- c) Flag: Used mostly on 900 μ m buffered cables (EX: Brady M71FT-1-425).
- d) Other: Other labeling material options are available upon request.

2. Label Length

Standard/default length is 2 inches (reference), as produced by most label manufacturers. Label length is governed by the label manufacturer.

3. Marking Details

Marking details are based on MIL-STD-130 and will be legible and permanent.

- a) Marking information example

- Cage code = 0YPM2 for AFSI, part number = 2006112209MD-01, serial number with date code embedded. The info can be provided in any order, and two lines of info are recommended.

0YPM2 2006112209MD-01
SN: YYDDDXXXX

NOTES:

- YY = Last two digits of year.
- DDD = Day of year.
- XXXX = Sequence number from 0001 to 9999.

b) Character size

- Character height of 0.1 inches is the default. Maximum number of characters per line is 22 to 25.
- Different character heights may be used for specific applications so that information fits into the available space on the label.
- All marking shall be legible or free from smears and smudges.

c) Number of lines of information

- In general, 1 to 2 lines of marking information are preferred on any label.
- 1 line of marking information is strongly recommended for labels installed on simplex cable.

d) Location

- Labels shall be located within 10 inches from the back of the connector or a distance that satisfies manufacturability. Standard tolerance shall be ± 2.0 inches; however, the tolerance should be as loose as possible or specified as "located approximately."

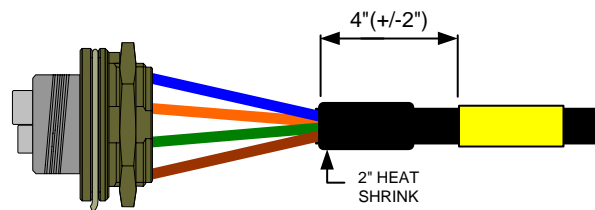

Figure-6

- Cable assembly pig-tails (fan-out) labels will be referenced from the tip of connectors. Standard tolerance shall be ± 3.0 inches; however, the tolerance should be as loose as possible.

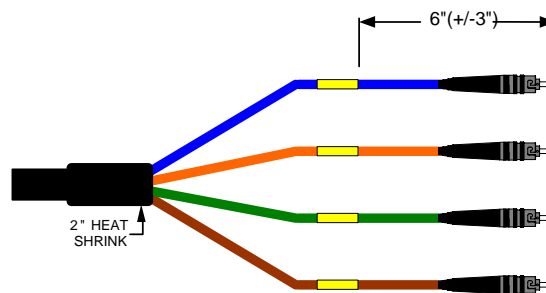

Figure-7

- Cable assembly lengths less than 6 feet shall utilize 1 label/marker for identification.
- Avoid placing label/marker in the middle of a cable assembly that is longer than 6 feet, especially when the cable is spooled onto a reel.

- When a cable assembly cannot be physically labeled, marked, or tagged due to inadequate space (extremely short assembly or cable diameter is too small, i.e. 900 μm buffered fiber), the label shall be applied to the bag or container that contains the assembly. Flag labels may also be considered.

e) Orientation

- Unless otherwise specified or defined on the drawing or purchase order, orientation of the identification label/marker shall be flexible. Example: the text can be read toward or away from the connector end.
- If marking orientation is required, it shall be specified on the drawing.

f) Permanency

- Marking should not smear when lightly rubbed with finger or with a Q-tip soaked in isopropyl alcohol.

D. CABLE ACCESSORIES

1. Standard Types

a) Furcation Tubing

This tubing provides protection for 250 μm or 900 μm buffered fiber and serves as a sub-unit or jacket similar to a breakout cable. Typical sizes are 1.6 mm, 2.0 mm and 3.0 mm.



b) Expando Wrap

This is the preferred method for cable management and protection with high flexibility and ruggedness. It is recommended for cabinets and shelters when short runs are utilized (< 50 ft). The most common material is polyester with sizes/diameters ranging from 0.25 to 1 inch and above. Example: 674900252 (1/4", BEGP-0500 (1/2"), BEGP-0750 (3/4").



c) Spiral Wrap

This wrap is good for cable management, providing protection and flexibility. The most common materials are polyester and nylon, with typical sizes/diameters ranging from 0.25 to 1 inch and above. Example: NSW-1/4 (1/4"), NSW-1/2 (1/2"). This option can be costly because the installation is labor intensive.



d) Convolutated/Corrugated Tubing

This tubing is good for cable protection but less flexible than those mentioned previously. Various materials are available (PTFE, Nylon, PEEK, etc.) and typical sizes/diameters range from 0.25 to 1 inch and above. Metallic tubing is not recommended because kinks in the tubing can cause damage to the fiber or cable.



e) Lacing Tape

This tape is good for cable management, but it provides no protection. The most common material is polyester braided, waxed, per MIL-T 43435B, TYPE II.



f) Heat Shrink

This accessory is typically used in conjunction with types a) through e). The most common types are M23053/4 and M23053/5.



g) Flexible Boots

Flexible boots are a good accessory to use for strain relief at the back of various connector types. Several boots are also used to create "Y" or "T" breakouts within cable assemblies. The main manufacturer is Raychem/Tyco.



E. COMPATIBILITY REQUIREMENTS

1. Fiber Sizes and Cable Types

a) Fiber Sizes

Multiple fiber sizes exist in the fiber optic world. The same fiber core size should be used to minimize optimize optical parameters such as insertion loss and return loss. Some circumstances, such as mode conditioning, warrant connecting different fiber sizes. The most common fiber sizes are listed below.

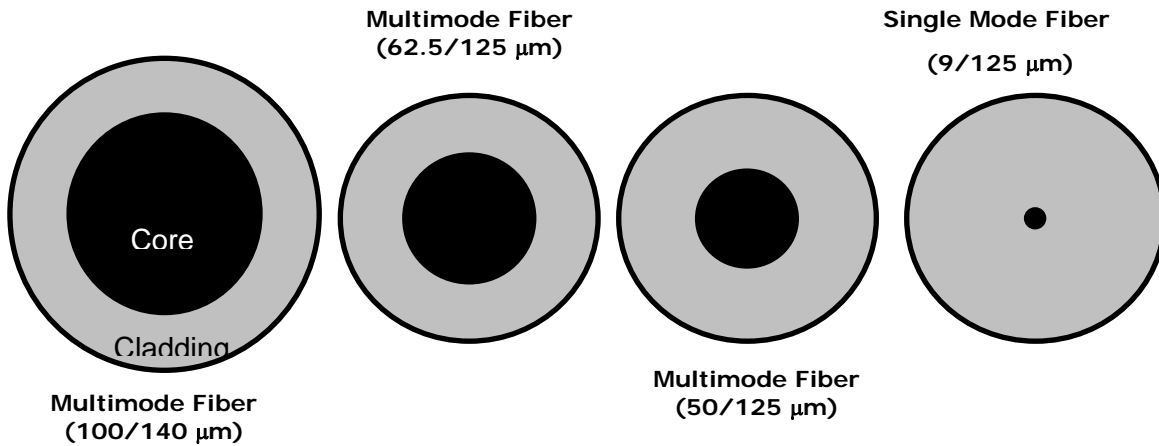

b) Cable Types

Three main cable types are typically chosen for harsh environments: simplex fiber, breakout fiber, and distribution fiber.

Simplex Fiber (sub-cable) and Breakout Cable

This type of cable is typically used with receptacle style connectors and naval plug style connectors.

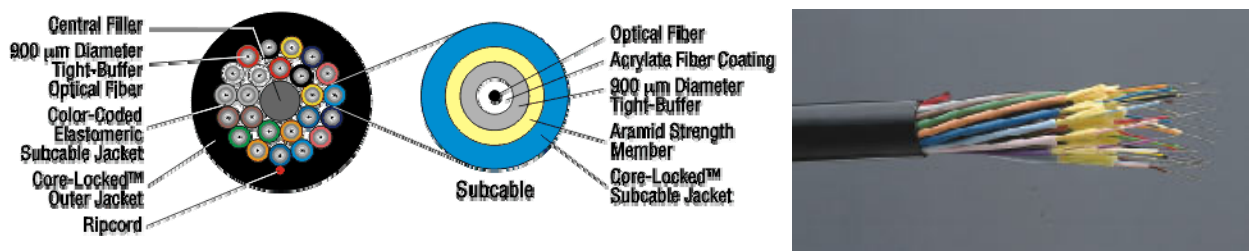





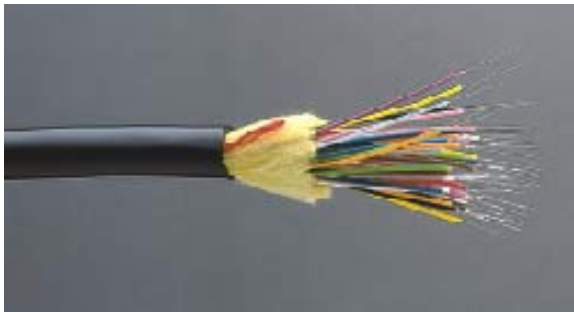
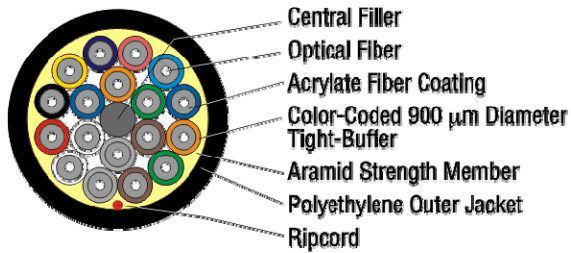



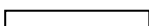

Distribution Cable

This type of cable is typically used with plug style connectors.



Simplex Cable Color Coding Chart for Pinouts

Fiber Number	Color Code	Fiber Number	Color Code
1	Blue 	13	Blue w/ black tracer
2	Orange 	14	Orange w/ black tracer
3	Green 	15	Green w/ black tracer
4	Brown 	16	Brown w/ black tracer
5	Slate 	17	Slate w/ black tracer
6	White 	18	White w/ black tracer
7	Red 	19	Red w/ black tracer
8	Black 	20	Black w/ black tracer
9	Yellow 	21	Yellow w/ black tracer
10	Violet 	22	Violet w/ black tracer
11	Rose 	23	Rose w/ black tracer
12	Aqua 	24	Aqua w/ black tracer

2. Commercial Connectors

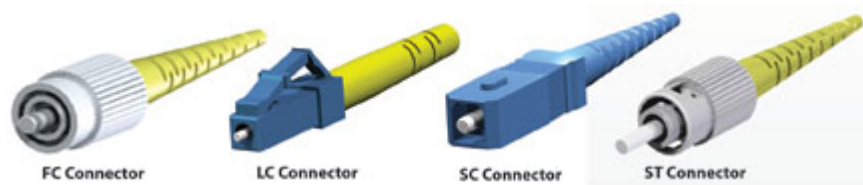

a) FC Connectors

The Fixed Connector (FC) has a threaded coupling feature for use in high-vibration environments. The threads are difficult to over tighten because stops have been installed to obtain repeatable torque. FC connectors are also available in an APC (angled physical contact) version with an 8 degree angle for increased return loss.

Ferrule: 2.5 mm zirconia ceramic

Latch: key alignment with threaded housing

Cable: 900u to 3 mm jacketed; loose buffered cable is required.

Boot/Crimp Sleeve: different boot and crimp sleeves are required for different cable ODs.

b) LC Connectors

Lucent Technologies designed the Lucent Connector (LC) as a smaller connector for premises cabling, data networking, and telecommunications applications. It is available in both simplex and duplex configurations. The connector doubles the density of existing ST and SC type designs.

Ferrule: 1.25 mm zirconia ceramic

Latch: key alignment push/pull

Cable: 900u to 3 mm jacketed; loose buffered cable is required.

Boot/Crimp sleeve: different boot and crimp sleeves are required for different cable ODs.

c) SC Connectors

Subscriber Connector (SC) is a fiber optic connector with a push-pull latching mechanism that provides quick insertion and removal while ensuring a positive connection. The SC is also available in a duplex configuration. Its keyed duplex capability supports send/receive channels. This connector is commonly used for most modern network applications. The SC is a snap-in connector that is extensively used in single mode systems due to its remarkable efficiency.

Ferrule: 2.5 mm zirconia ceramic

Latch: key alignment push/pull

Cable: 900u to 3 mm jacketed; loose buffered cable is required.

Boot/Crimp sleeve: different boot and crimp sleeves are required for different cable ODs.

d) ST Connectors

The Straight Tip (ST) connector was designed by Bell Laboratories for both single mode and multimode applications. The ST connector uses a quick-release bayonet that can be used in high vibration environments.

Ferrule: 2.5 mm zirconia ceramic

Latch: key alignment with bayonet push and turn, 3.5 to 5 lb spring available

Cable: 900u to 3 mm jacketed; loose or tight buffered cable can be used.

Boot/Crimp Sleeve: different boot and crimp sleeves are required for different cable ODs.



e) AFSI Preferred Commercial Parts List

The AFSI preferred parts list for off-the-shelf fiber optic commercial parts is shown below. For most categories, an AFSI part number is assigned. There can be multiple manufacturers under the AFSI part number. AFSI has researched the industry and selected the best manufacturers based on ruggedness, quality, availability, manufacturability and cost. If a manufacturer is listed under a connector type, then that specific manufacturer is the only qualified source.

Connector Type	Part Number	Comments
LC / Tyco	6828094-1 MM simplex, 2 mm 6828129-1 MM duplex, 2 mm 6828095-1 SM simplex, 2 mm 6828130-1 SM duplex, 2mm	Special configuration for tight buffered cables. Functions like an ST connector where the ferrule and cable move together. 4x cost of standard LC connectors
LC / AFSI	BLCC1588705-1 MM simplex, 2mm BLCC1588707-1 MM duplex, 2mm BLCC1588709-1 SM simplex, 2mm BLCC1588709-1 SM duplex, 2 mm	Standard LC connectors
SC / AFSI	BSCC2000-BK-1 MM simplex, 2 mm BSCC2000-BL-1 SM simplex, 2 mm BSCC2000A, SM APC, simplex, 2 mm	Add FS29999S clip for duplex Add FS29999S-BL clip for duplex
ST (MIL) / AFSI	MSTC1000 MM with boot ring MSTC1001 MM with screw-on boot MSTC2000 SM with boot ring MSTC2001 SM with screw-on boot	MIL style connectors have a 5 lb. spring.
ST (COTS) / AFSI	MSTC1100 MM with boot ring MSTC2100 SM with boot ring	COTS style connectors have a 3.5 lb. spring.
FC / AFSI	BFCC1000-BK-1 MM, 2 mm BFCC2000-BL-1 SM, 2 mm	

3. TFOCA-II®

TFOCA-II® connectors are typically used in any type of harsh environment such as military tactical, mining, industrial, broadcast, and oil and gas. The hermaphroditic design is versatile because it allows multiple plugs to be daisy chained. The connectors are used with simplex, distribution, and breakout cable. The outer diameter of sub-units can be from 1.6 to 3.0 mm. We recommend that distribution cable be used with plugs and breakout cable be used with receptacles. The plug design allows for 400 lbs. of cable retention strength while protecting the fibers from stress. Various coatings and materials are available depending on the corrosion resistance required; these include zinc nickel, black anodize, zinc cobalt, brass, and stainless steel. The connectors are field repairable and reuse existing parts other than the contacts or termini.

Similar keying options should be utilized to ensure proper mating. Four key options are available.

a) TFOCA-II® Plugs

The table and the plug figure below describe the part numbering scheme for ordering the proper plug configuration. It is critical to know the cable outer diameter when choosing the proper configuration (reference column 4). Other connector choices are available in 6, 8, 12, and 24 channel configurations.

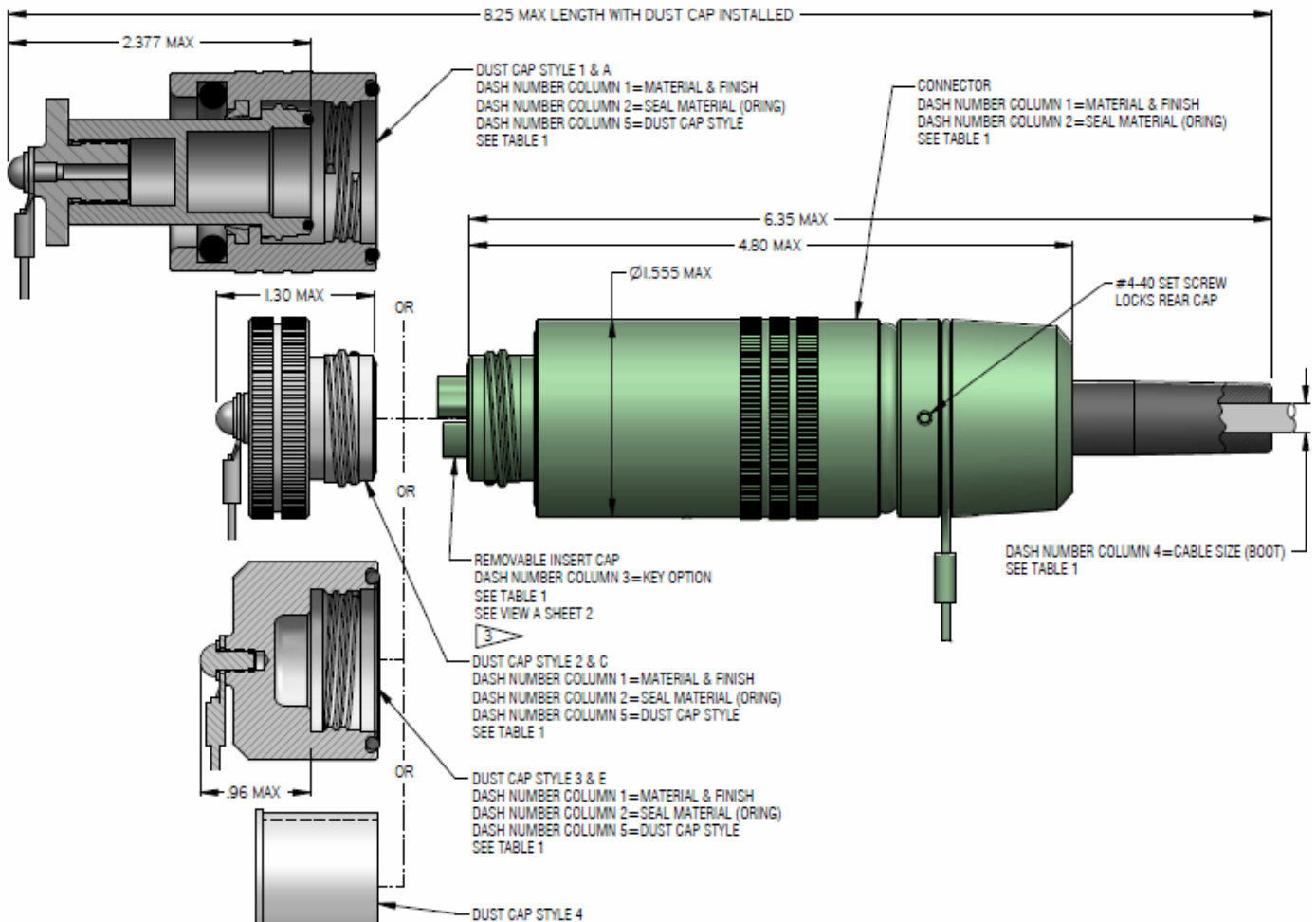

TABLE 1 PRODUCT NUMBER DEFINITION

PART NO.	DESCRIPTION
FS4H1000-#####	DASH NUMBER COLUMN 1 = MATERIAL & FINISH
FS4H1000-2#####	2 = 6061-T6 Zn-Ni COLOR OD
FS4H1000-3#####	3 = 6061-T6 GLOSS BLACK HARD ANODIZE PTFE
FS4H1000-4#####	4 = 6061-T6 MATTE BLACK HARD ANODIZE PTFE
FS4H1000-6#####	6 = 6061-T6 Zn-Co COLOR OD
FS4H1000-8#####	8 = 6061-T6 Zn-ALLOY COLOR OD
FS4H1000-A#####	A = C63000 BRONZE
FS4H1000-B#####	B = C36000 BRASS 360
FS4H1000-C#####	C = 303 STAINLESS STEEL
FS4H1000-D#####	D = 303 STAINLESS STEEL MATTE
FS4H1000-E#####	E = 304 STAINLESS STEEL
FS4H1000-F#####	F = 316 STAINLESS STEEL
FS4H1000-G#####	G = 316 STAINLESS STEEL NICKEL PLATED
FS4H1000-#####	DASH NUMBER COLUMN 2 = SEAL MATERIAL (ORING)
FS4H1000-#A###	A = NITRILE ORING/SEAL
FS4H1000-#B###	B = EPDM ORING/SEAL
FS4H1000-#####	DASH NUMBER COLUMN 3 = KEY OPTION
FS4H1000-##1##	1 = KEY 1, GREY
FS4H1000-##2##	2 = KEY 2, BLUE
FS4H1000-##3##	3 = KEY 3, RED
FS4H1000-##4##	4 = KEY U, GREEN
FS4H1000-##6##	6 = 2 CHANNEL
FS4H1000-#####	DASH NUMBER COLUMN 4 = CABLE SIZE (BOOT)
FS4H1000-###P#	P = CABLE RANGE .150-190
FS4H1000-###H#	H = CABLE RANGE .190-239
FS4H1000-###F#	F = CABLE RANGE .240-279
FS4H1000-###N#	N = CABLE RANGE .270-290
FS4H1000-###A#	A = CABLE RANGE .280-315
FS4H1000-###B#	B = CABLE RANGE .316-346
FS4H1000-###G#	G = CABLE RANGE .347-379
FS4H1000-###C#	C = CABLE RANGE .380-423
FS4H1000-###D#	D = CABLE RANGE .424-465
FS4H1000-#####	DASH NUMBER COLUMN 5 = DUST CAP STYLE
FS4H1000-####1	1 = DUST CAP ASSY, HERMAPHRODITIC, 4/6CH, LANYARD LENGTH 12"
FS4H1000-####2	2 = DUST CAP ASSY, MALE, 4/6CH, LANYARD LENGTH 12"
FS4H1000-####3	3 = DUST CAP ASSY, FEMALE, 4/6CH, LANYARD LENGTH 12"
FS4H1000-####4	4 = DUST CAP, PLASTIC (CAPSEAL)
FS4H1000-###C	C = DUST CAP ASSY, MALE, 4/6CH, PLASTIC, LANYARD LENGTH 12"
FS4H1000-###E	E = DUST CAP ASSY, FEMALE, 4/6CH, PLASTIC, LANYARD LENGTH 12"

EXAMPLE: FS4H1000-2A1B1 DESCRIBES:
 PLUG ASSY, HERMAPHRODITIC TFOCA-II® 4CH WITH:
 6061-T6 AL ALY Zn-Ni COLOR OD, NITRILE ORING/SEALS, KEY OPTION 1,
 CABLE SIZE B .316-.346, DUST CAP STYLE HERMAPHRODITIC



KEY OPTION 1

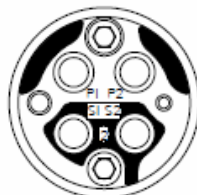

KEY OPTION 2

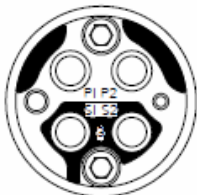

KEY OPTION 3

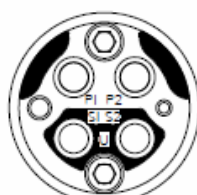

KEY OPTION UNIVERSAL

b) TFOCA-II® Receptacles

The receptacle figure and table below describe the part numbering scheme for ordering the proper receptacle configuration. Other connector choices are available in 6, 8, 12, and 24 channel configurations.

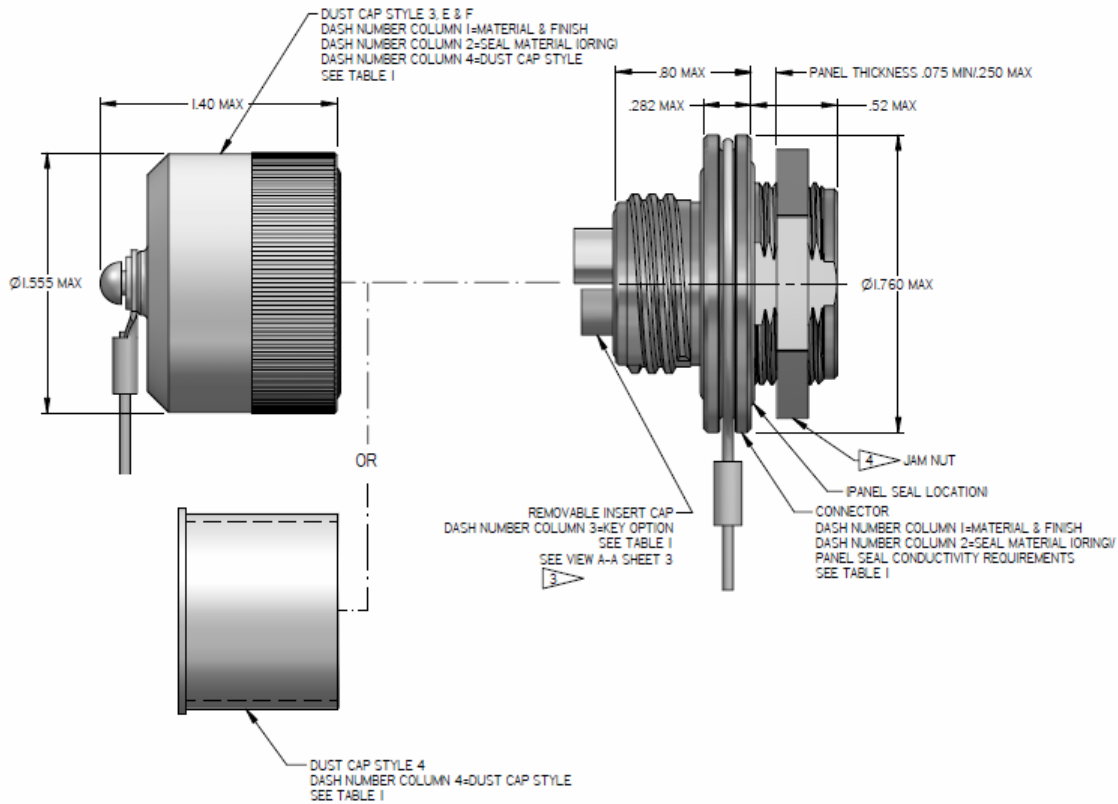
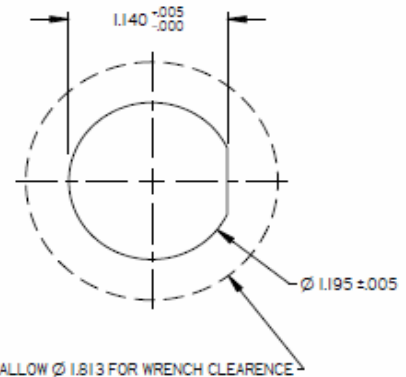

TABLE I PRODUCT NUMBER DEFINITION	
PART NO.	DESCRIPTION
F04H8000-#####	DASH NUMBER COLUMN 1 = MATERIAL & FINISH
F04H8000-2###	2 = 6061-T6 AL ALY ZN-NI COLOR OD
F04H8000-3###	3 = 6061-T6 AL ALY GLOSS BLACK HARD ANODIZE PTFE
F04H8000-4###	4 = 6061-T6 AL ALY MATTE BLACK HARD ANODIZE PTFE
F04H8000-6###	6 = 6061-T6 AL ALY ZN-CO COLOR OD
F04H8000-8###	8 = 6061-T6 AL ALY ZN-ALLOY COLOR OD
F04H8000-A###	A = C63000 MARINE BRONZE
F04H8000-B###	B = C36000 BRASS 360 1/2 HARD
F04H8000-C###	C = 303 STAINLESS STEEL PASSIVATED
F04H8000-D###	D = 303 STAINLESS STEEL MATTE PASSIVATED
F04H8000-E###	E = 304 STAINLESS STEEL PASSIVATED
F04H8000-F###	F = 316 STAINLESS STEEL PASSIVATED
F04H8000-#####	DASH NUMBER COLUMN 2 = SEAL MATERIAL (ORING) / PANEL SEAL CONDUCTIVITY REQUIREMENTS
F04H8000-A##	A = NITRILE ORINGS / NITRILE NON-CONDUCTIVE PANEL SEAL (ORING)
F04H8000-B##	B = EPDM ORINGS / EPDM NON-CONDUCTIVE PANEL SEAL (ORING)
F04H8000-C##	C = NITRILE ORINGS / FLUOROSILICONE CONDUCTIVE PANEL SEAL (ORING)
F04H8000-D##	D = EPDM ORINGS / EPDM CONDUCTIVE PANEL SEAL (ORING)
F04H8000-#####	DASH NUMBER COLUMN 3 = KEY OPTION
F04H8000-##1#	1 = KEY 1, GREY
F04H8000-##2#	2 = KEY 2, BLUE
F04H8000-##3#	3 = KEY 3, RED
F04H8000-##4#	4 = KEY U, GREEN
F04H8000-#####	DASH NUMBER COLUMN 4 = DUST CAP STYLE
F04H8000-###3	3 = DUST CAP ASSY, FEMALE, 4/6CH, LANYARD LENGTH 10"
F04H8000-###4	4 = DUST CAP, PLASTIC (CAPPLUGS)
F04H8000-###E	E = DUST CAP ASSY, FEMALE, 4/6CH, PLASTIC, COLOR BLK, LANYARD LENGTH 10"
F04H8000-###F	F = DUST CAP ASSY, FEMALE, 4/6CH, PLASTIC, COLOR OD, LANYARD LENGTH 10"

EXAMPLE: F04H8000-2A13 DESCRIBES:
 RECEPTACLE ASSY, JAM NUT, EXTERNAL MOUNT, TFOCA-II® 4CH WITH:
 6061-T6 AL ALY ZN-NI COLOR OD,
 NITRILE ORINGS / NON-CONDUCTIVE NITRILE PANEL SEAL (ORING),
 KEY OPTION 1,
 DUST CAP STYLE FEMALE



PANEL CUT-OUT DIMENSIONS

4. M28876 Connectors

M28876 connectors are typically used with simplex and breakout cable. They can also be used with distribution cable. The sub-units shall be 1.6 to 2.0 mm. 3 mm sub-units should not be used due to the insert cavity ID size.

Similar keying options should be utilized to ensure proper mating.

Pin inserts are standard for plugs, and socket inserts are standard for receptacles. Pin inserts can be used in receptacles, and socket inserts can be used in plugs upon request. See table for pin and socket part numbers.

M28876/	Mode/Fiber Size	Pin Insert	Socket Insert
4, 8, 31 Channel Plug/Receptacle	MM / 62.5 um MM / 50 um	Pin termini, M29504/14-4131C	Socket termini, M29504/15-4171C, includes captivator (alignment sleeve)
4, 8, 31 Channel Plug/Receptacle	SM / 9 um	Pin termini, M29504/14-4141C	Socket termini, M29504/15-4181C, includes captivator (alignment sleeve)

It is important to choose the correct part number depending on the connector type, shell size, insert type, channel count, key designation, terminus type and cable outer diameter. Tables 5.1 through 5.3 and the figure below describe these characteristics. It is also critical to choose the correct backshell designator; one must know the exact cable diameter prior to choosing the correct designator.

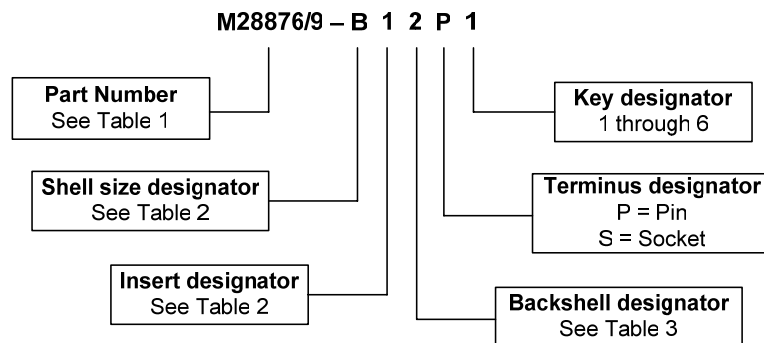

Connector Type	Backshell	PN
Receptacle – Wall Mount	Straight	M28876/2
	45°	M28876/3
	90°	M28876/4
Plug	Straight	M28876/7
	45°	M28876/8

	90°	M28876/9
Receptacle – Jam Nut	Straight	M28876/12
	45°	M28876/13
	90°	M28876/14

Table 5.2			
Shell Size	Shell Size Designator	Insert Designator	Channel Count
13	B	1	4
15	C	1	8
		2	6
23	F	1	31
		2	18

Table 5.3			
Backshell Designator	Maximum Cable Diameter (inches)		
	Shell Size 13	Shell Size 15	Shell Size 23
1	0.280 – 0.315	0.495 – 0.515	0.768 – 0.868
2	0.305 – 0.346	0.380 – 0.423	0.900 – 1.000
3		0.423 – 0.465	0.550 – 0.660
4		0.305 – 0.346	0.660 – 0.768

Multiple dust cap options are available for M28876 connectors per the table below.

Connector Type		Dust Cap PN	Dust Cap Option	Comments
Plug	4 Channel (shell size 13)	M28876/10B__	A = Chain w/ fastener B = Chain w/ ring C = Rope w/ fastener D = Rope w/ ring E = Dust cap only	
	8 Channel (shell size 15)	M28876/10C__		
	31 Channel (shell size 23)	M28876/10F__		
Receptacle	4 Channel	M28876/15B__		
	8 Channel	M28876/15C__		
	31 Channel	M28876/15F__		

F. SPARE CABLE, CONNECTOR CHANNELS AND PINOUTS

All spare connector channels should utilize dummy termini to maintain sealing for the connector.

Spare fibers can be terminated and stored inside certain connector back shells or stored as unterminated fibers.

Pinouts shall be specified on the drawing. Hermaphroditic connectors are typically crossed to allow for transmit and receive channel hookups. Loopback pinouts are acceptable as long as the fiber bend radius is not exceeded. Contact the manufacturer when loopbacks are required.

G. CABLE BEND RADII - REEL APPLICATIONS AND FORMED CABLE LOOPS

Bending fiber optic cable causes attenuation or insertion loss within the cable. Exceeding certain bend radii can cause the fiber to crack or fracture. The recommended bend radius when placing a fiber optic cable on a reel or in a fixed installation is noted below. The radius of the reel core or bend shall be equal to or greater than the minimum bend radius in the table.

Cable Type	Minimum Bend Radius As a Multiple of Overall Cable Diameter
Fiber Optic Cable	10 times overall diameter for multimode cables 20 times overall diameter for single mode cables

H. OPTICAL TEST REQUIREMENTS

1. Link Loss Considerations

The diagram below shows how system link loss is calculated. Typical loss budgets are determined by the transmitter and receiver specifications. Most receivers can operate with greater than 10 dB of loss. It is a good practice to de-rate or add some room for margin when designing optical systems.

Typical transmitter-receiver link margin ~10 dB

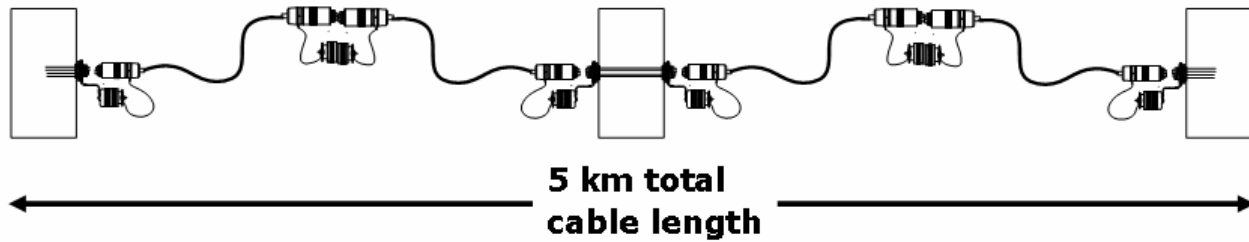

Cable Loss		
Fiber Type	Loss / km	Loss over 5 Km
850 nm Multimode	3 dB	15 dB
1300 nm Multimode	1 dB	5 dB
1550 nm Singlemode	0.2 dB	1 dB

Connector Loss =
 $(6 \text{ connectors}) \times (0.75 \text{ dB/con.}) = 4.5 \text{ dB}$

Link Loss Specification:
 Link Loss = Connector Loss + Cable Loss
 Link Loss = 4.5 dB + cable loss

Single Cable Assembly Specification:
 $2 \text{ connectors} \times 0.75 \text{ dB/con.} = 1.5 \text{ dB}$

2. Insertion Loss

Insertion Loss (IL) is the amount of optical power lost as light is transmitted through a fiber and connections. IL is usually expressed in decibels (dB).

Insertion loss should be specified for any mated pair (connectors or termini) or fiber optic link (cable assembly) along with the wavelength (850nm – 1550nm). It is important to identify which loss is being specified (connection or link).

3. Return Loss or Back Reflection

Return Loss (RL) or Back Reflection (BR) refers to the light returned or reflected from a connection or raw cable.

Return loss should be specified for any single mode mated pair (connectors or termini) or fiber optic link (cable assembly) along with the wavelength (1310 – 1550nm). Return loss is not normally specified for multimode connections or cables. Please inquire if multimode return loss is required.

Product	Comments	ILmax (dB)	RL or BR (Single mode)
TFOCA	Utilizes biconic style termini. Obsolete technology.	1.25	NA
TFOCA-II [®] , TFOCA-III [®] , THD		0.75	43
M28876		0.75	43 60 (APC)
D38999	Enhanced versions are available with lower losses.	1.0	40
Expanded Beam	Enhanced versions are available with lower losses.	2.0	35
LC, SC, ST, FC	Best practice: utilize same manufacturer within each application if possible.	0.5 to 0.75	45 55 (APC)

4. Termini End Face Geometry and Visual Requirements

Termini end face geometry and visual quality requirements should be specified to optimize the reliability and optical performance of optical links and cable assemblies. Several standards exist within the industry. Manufacturing processes should utilize tools that control these parameters. Reference AFSI's technical paper on "End Face Quality Standards" for details and further information.

Company Overview

Amphenol Fiber Systems International (AFSI), a division of Amphenol, provides reliable and innovative fiber optic interconnect solutions that withstand the harsh environments of military (ground systems, avionics, shipboard), energy and broadcast applications. After more than 18 years in business, AFSI maintains its position as a global leader in fiber optic interconnect components and systems such as termini, M28876, 38999 assemblies, MIL-ST, TFOCA and the TFOCA-II® connector, which AFSI developed and patented. AFSI has delivered millions of fiber optic connectors in more than 34 countries. Whenever there is a need for superior cost-effective fiber optic systems and products that will stand up to demanding operating environments, you can rely on AFSI for engineering know-how, top-quality products and expert technical support.

Amphenol Fiber Systems International

1300 Central Expressway N, #100

Allen, TX 75013

T: (214) 547-2400

F: (214) 547-9344

www.fibersystems.com

sales@fibersystems.com

About the Authors

Bill Waite, Vice President of Operations

Bill joined Amphenol Fiber Systems International (AFSI) in July 2002 as a Systems Engineer. He is currently responsible for building operations infrastructure in order to sustain AFSI's rapid growth. Bill uses his product development and operations expertise to provide the required focus and direction, enabling AFSI to become a world-class fiber optic connector and cable assembly manufacturer. Bill has over 21 years of hands-on experience in planning, executing, and accomplishing various tasks associated with product development and manufacturing of advanced electronic, fiber optic and electro-optical integrated products. Bill was previously employed at Optical Switch Corporation, Abbott Laboratories Diagnostics Division, Texas Instruments Defense Systems and Electronics Group, and Boeing. These positions enabled Bill to gain extensive experience in transitioning products from development to production through engineering analyses, design and process verification testing, as well as implementing advanced quality concepts such as six sigma, design for manufacturability, and QS9000 Production Part Approval Process. Bill also has experience in material and supply chain management in the areas of cost reduction, quality improvements, and cycle time reduction. Bill earned a Bachelor of Science degree in Electrical Engineering from the University of West Virginia in 1988.

Chuong Nguyen, Manufacturing and Process Engineer

Chuong joined Amphenol Fiber Systems International (AFSI) in July 2002 as a Test Engineer. He is currently responsible for cable assembly manufacturability. Chuong obtained his product development and operations experience from a variety of technical industries such as aeronautical/space program, telecom, software development, and fiber optics product manufacturing. Chuong has over 15 years of hands-on experience in requirements definition capturing, product development/implementation/integration, and product deployment & training planning. Chuong was previously employed at NASA Johnson Space Center (Unisys Space Systems), Raytheon E-Systems, Sprint Corporation, and Alcatel USA Inc. Chuong earned a Bachelor of Science degree in Aerospace Engineering from the University of Texas at Arlington in 1991.