

Expanded Beam

Fiber Optic solutions for Harsh Environments
Military Ground Systems,
Industrial Heavy Duty Environments



About Amphenol

Amphenol was founded in 1932. The company is one of the largest manufacturers of interconnect products in the world. The company designs, manufactures and markets electrical, electronic and fiber optic connectors, interconnect systems and coaxial and at-ribbon cable.

Amphenol Socapex designs, manufactures and provides electrical and optical connectors and interconnection systems, ideally suited to harsh environment needs.

Our key markets are focused on mil-aero and industrial applications such as : C4ISR, commercial and military airframe, marine, ground vehicles, weapons and munitions, space and homeland security, machine tool, oil & gas, mining, railway, entertainment, and medical equipment. Amphenol-Socapex is aware of environmental issues. Indeed, most of our solutions are compliant with the European ROHS directive regarding electrical and electronic.

Amphenol Socapex devotes an important part of its budget to Research & Development, and owns all the resources needed to develop custom design products to match customer demands.

Amphenol-Socapex is recognized as a specialist of MIL-DTL-38999 derived products, high density PCB connectors, field bus and rugged Ethernet solutions, and harsh environment optical connectors.

Amphenol Fiber Optic Capabilities

For over 20 years, Amphenol Socapex has developed a strong expertise as a designer, integrator, manufacturer and solutions provider in the field of High performance Fiber Optic Interconnection.

Amphenol Fiber Optic Interconnection Solutions are tailor made to suit the needs of very demanding customers, manufacturing mission critical or safety related equipments.

This leads us to a long term commitment and partnership with our customers and to provide maintenance, repair, training, technical support, on demand.

Our Fiber Optic Solutions are based on High performance optical termini, innovative design, and high quality, well proven connector technology.

Rigorous internal quality assurance systems exceed the ISO 9001 requirements and ensure consistent quality products regardless of manufacturing location.



Amphenol Socapex Quality & Environmental Certification



Quality certification :
ISO 9001 : 2000
Thyez (France) and Pune (India)



Aeronautical market quality certification :
EN9100 : 2003
Thyez (France) and Pune (India)



Military market quality certification (NATO) :
AQAP 2110
Thyez (France)



Environnemental certification :
ISO 14001 (2004)
Thyez (France)

TABLE OF CONTENTS

Expanded Beam

Expanded Beam Specifications 4-5

CTOS-CTOL-CNOS-CROS

CTPS-xx 77 "Jam nut" receptacle - Rear mount 6-9
 CTOL-xx 00 "Square flange" receptacle - Rear mount 10-11
 How to order CTOS and CTOL - Piece part 12
 How to order CTOS and CTOL plug to plug - Patchcord 13
 How to order CTOS and CTOL to others connectors - Patchcord 12
 How to order CTOS shunt caps 15

AXOS-e

AXOS-e LINE drawings 16-17
 How to order AXOS-e - Piece part 18
 How to order AXOS-e plug to plug - Patchcord 19
 How to order AXOS-e to others connectors - Patchcord 20

TACBeam

TACBeam line drawings 20-21
 How to order TACBeam - Piece part 21
 How to order TACBeam plug to plug - Patchcord 21
 How to order TACBeam to others connectors - Patchcord 22

EUROCOM II

Eurocom II line drawings 23
 How to order eurocom II plug to plug - Patchcord 24
 How to order Eurocom II to others connectors - Patchcord 25

Deployable Cable Drums

Tactical Drums 26-27
 Compact Drums 28-29







Tactical Cable

..... 30

FTOS (Flexible tactical Optical Splice) 31

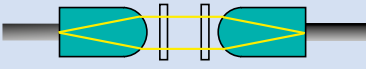

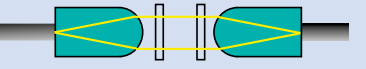
Military Ethernet Media Converter 32-35

CONNECTOR TYPE	CTOS/CTOS-A , CNOS CROS	CTOL
		
Number of channels	1/2/4	2/4/6/8
Outer diameter in mm	38	52
Coupling device	Rapid ramp	Rapid ramp
Lens+Window	X	X
Lens		
Multimode version		
Insertion loss @ 1300nm (DEL source) Typical/maxi	-1.5/-2db	-1.5/-2db
Singlemode version		
Insertion loss @ 1300nm & 1550nm (Laser source) Typical/maxi	-1.8/-2.5db	-1.8/-2.5db
Return Loss @ 1300nm & 1550nm Typical/maxi	-53/-45db	-53/-45db
Durability (number cycle maximum)	CTOS 10000 MIL-STD-810-E CTOS-A 5000 MIL-STD-810-E	10000 MIL-STD-810-E
Operating temperature	-40°C/+85°C MIL-STD-810-E	-40°C/+85°C MIL-STD-810-E
Storage temperature	-55°C/+85°C MIL-STD-810-E	-55°C/+85°C MIL-STD-810-E
Salt spray (minimum)	500 hours/340 hours	500 hours
Crush resistance	1 ton/10 sec/-	1 ton/10 sec
Water Immersion	Up to 20m depth	Up to 20m depth
Sinus vibrations	10 to 20000Hz, 10g, 1.5mm p/p 3dir	10 to 20000Hz, 10g, 1.5mm p/p 3dir
Free drops	26 drops 1.2m on concrete (plugs) MIL-STD-810-E	26 drops 1.2m on concrete (plugs) MIL-STD-810-E
Mechanical shocks	50g 1/2 sinus, 3 shocks per dir, 3 axes, MIL-STD-810-E	50g 1/2 sinus, 3 shocks per dir, 3 axes, MIL-STD-810-E
Bump resistance	4000 bumps, 40g, 6ms, 6 dir	4000 bumps, 40g, 6ms, 6 dir
Tensile load : short time/permanent	CTOS 2200N up to 1 hour/ 1300N CTOS-A 2200N up to 5 min/ 1300N	2200N up to 1 hour/ 1300N
Decontamination fluid resistance	compliant	compliant
Standard	STANAG 4290	
TECHNOLOGY	Multimode  Singlemode 	Multimode  Singlemode 

CONNECTOR TYPE	AXOS-e	TACBeam	EUROCOM II
			
Number of channels	2/4	2/4	2
Outer diameter in mm	27	27	59
Coupling device	Rapid ramp	Thread	Rapid ramp
Lens+Window	X		X
Lens		X	
Multimode version			
Insertion loss @ 1300nm (DEL source) Typical/maxi	-1.5/-2db	-.7/-2,5db	-1/-1.5db
Singlemode version			
Insertion loss @ 1300nm & 1550nm (Laser source) Typical/maxi	-	-.7/-2,5db	-
Return Loss @ 1300nm & 1550nm	-	-34 db unmated	-
Durability (number cycle maximum)	2500	3000	-
Operating temperature	-40°C/+85°C	-46°C/+71°C	-40°C/+70°C
Storage temperature	-55°C/+85°C	-57°C/+85°C	-55°C/+85°C
Salt spray (minimum)			
Crush resistance			
Water Immersion		Up to 15m depth	Up to 2m depth
Sinus vibrations		EIA/TIA 455-11, sinusoidal condition III (at 10g), random condition VI (letter C) for 1.5 hours	10 to 500Hz, 10g, 1.5mm p/p 3dir
Free drops			500 drops 1.2m on concrete (plugs)
Mechanical shocks		EIA/TIA 455-14, test condition A	
Bump resistance			4000 bumps 40g
Tensile load : short time/permanent			1800N
Decontamination fluid resistance	compliant	compliant	compliant
Standard		MIL 83526/20 & 21	

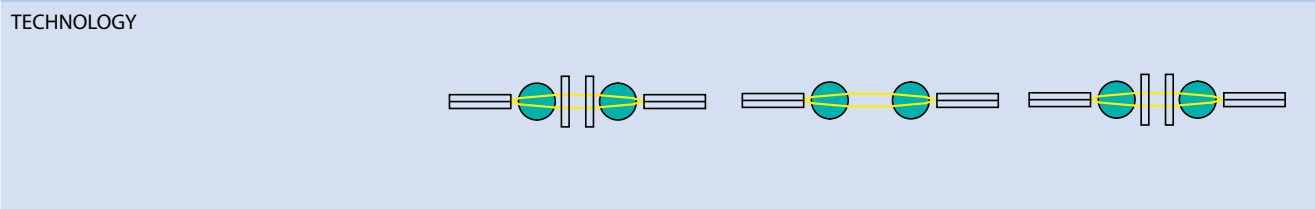

CTOS

CTOS: Small Optical Field Connector

CTOL: Large Optical Field Connector



CTOS



CTOL

CTOS and CTOL series are robust optical connectors for rapid deployment of high-speed transmission links under harsh environments. The hermaphroditic mating makes it possible to "daisy chain" cable assemblies without using any interconnect adapters. The specific lens design guarantees a large beam diameter and a low loss connection, less sensitive to dirt and dust. A specific front design and ergonomic keys ensure blind mating. The flat protective window mounted on shock absorbers provides an easy to clean surface for improved performances and protection. CTOS and CTOL harnesses are easily and cost effective field maintainable with the FTOS splice kit.

Amphenol unique CTOS and CTOL design have already gained worldwide acceptance in the ground military using. CTOS has been qualified by NATO according to STANAG 4290 requirements. These products are also widely used in geophysical, civil safety, railway, broadcast and industrial markets.

In the CTOS, 1, 2 or 4 channels are inserted in a small size design (o.d. 38mm). CTOL is a CTOS larger version up to 8 channels (o.d. 52mm). CTOL is intermateable with CTO, the first expanded beam connectors version.

- Hermaphroditic interface with rapid ramp coupling
- Design for gloved handling and blind mating in difficult conditions
- Large expanded beam
- Anti-reflective protective window easily reached and cleaned
- The rubber ergonomic shell allows an easy handling with or without gloves and ensures a high protection against shocks
- Up to 8 channels
- Cost effective field repairs
- Multimode Wavelength 850 - 1300 nm (Z version); 1300 nm (Y version)
- Singlemode Wavelength 1300 - 1550 nm (W version)

Derived product from CTOS

CNOS : navy optical field connector



CNOS is the Pier Side version of CTOS connector. The design provides flexibility for current and future Navy communication requirements both afloat and ashore. These connectors are designed for installation into Pier Side. The hermaphroditic mating makes it possible to "daisy chain" cable assemblies without using any interconnect adapters.

The specific lens design guarantees a large beam diameter and a low loss connection, less sensitive to dirt and dust. A specific front design and ergonomic keys ensure blind mating. The flat protective window mounted on shock absorbers provides an easy to clean surface for improved performances and protection. CNOS harnesses are easily to deploy with drum dedicated for afloat and ashore applications.

CROS : railway optical car jumper



CROS is the Railway version of CTOS connector. The design provides flexibility for current and future Railway communication requirements for cars jumpers.

The hermaphroditic mating makes it possible to "daisy chain" cable assemblies without using any interconnect adapters. The specific lens design guarantees a large beam diameter and a low loss connection, less sensitive to dirt and dust. A specific front design and ergonomic keys ensure blind mating. The flat protective window mounted on shock absorbers provides an easy to clean surface for improved performances and protection.

CTOS and CTOL Expanded beam technology FEATURES:



With AMPHENOL expanded beam technology, fibers are not in physical contact. The beam is expanded through the first lens and refocused through the second lens then into the fiber. By increasing the light beam surface (680 times for multimode technology and 5000 times for singlemode technology), the connector becomes highly resistant to vibrations, shocks, small debris contamination and optical misalignment. A coated protective window makes the connectors easy to clean. It is easily field maintainable if any damage occurs.

■ CTOS/CTOS MM

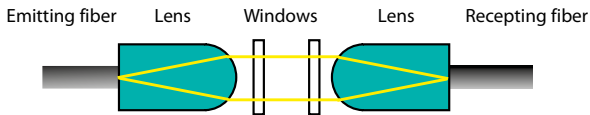

■ CTOS/CTOS SM

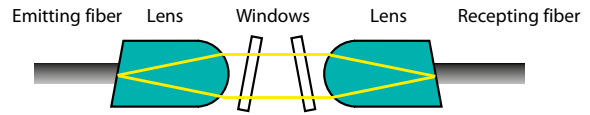

Channels Arrangements:

■ CTOS



1 Channel



2 Channels



4 Channels

■ CTOL



2 Channels



4 Channels



6 Channels



8 Channels

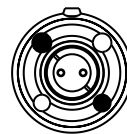

25 Channels



45 Channels

CTOS : line drawings (dimensions in mm)

CTOS 06M/CTOL 06M : plug

The CTOS or CTOL plug provides hermaphroditic optical links between two points. This plug is designed to be used in harsh environment applications.

The tensile strength between plug and cable can reach 200 daN (depending on cable performance)

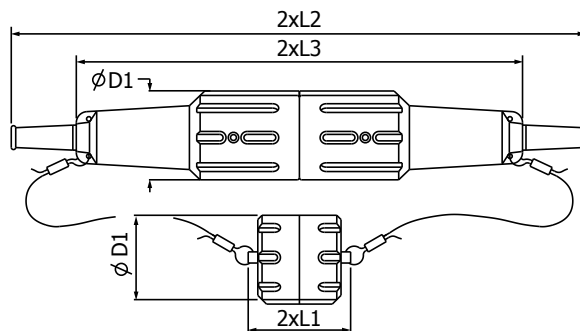
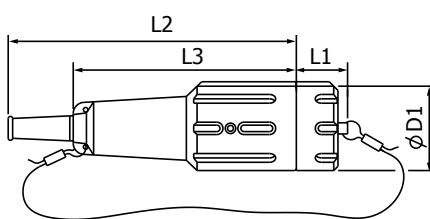

SERIES	L1	L2	L3	φD1
CTOS	23	129	100	37,8
CTOL	27	148	119	52

CTOS 77 "jam nut" Receptacle – rear mount

The jam nut receptacle has to be mounted on the vehicle panel or on a box, it provides the link between the inside electro optic device and the outside optical link. The jam nut receptacle is mated with the first plug of the outer link patchcord. Fixed by means of an hexagonal nut with possibility to be stopped using a brake wire. Front sealing ensured by an "O" ring. Electrical contact between panel receptacle and protective cap (for EMI,CEM protection when cap is on). Protective cap is attached to the receptacle by a stainless steel rope and ring.

CTOS 77P : Straight Backshell Receptacle for pigtail

BACKSHELL MAIN USE :

To be used inside a vehicle or on a box to connect CTOS receptacle to the electro-optic transceivers, in a protected area. This rear part provides an easy cross connect output. Each pigtail can be terminated with ST, SC, FC, duplex SC, duplex LC, MTRJ connectors. Pigtails tensile strength : 10 daN. (depending on cable performance).

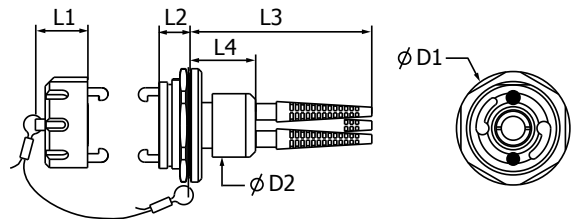

SERIES	L1	L2	L3	L4	φD1	φD2
CTOS MM*	23	13.6	82	29	49.9	28
CTOS SM**	23	13.6	90.5	38.7	49.9	28

CTOS 77C00 : Straight Backshell Receptacle for TACTICAL CABLE

BACKSHELL MAIN USE :

To be used inside a vehicle or on a box to connect CTOS receptacle to the electro-optic transceivers, in a non protected area. Unsealed straight backshell to be used with 1 or 2 tactical cables (1,2 or 4 number of channels) inside a vehicle. The rear part is made of 2 half shells molded in aluminum alloy. Possibility to add a multi channel connector at the other cable end. Cable/receptacle tensile strength : 100 daN (depending on cable performance).

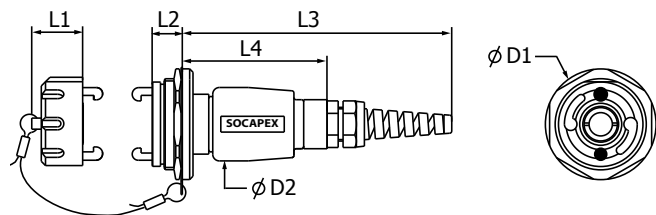

SERIES	L1	L2	L3	L4	φD1	φD2
CTOS MM*	23	13.6	132 max	64.7	49.9	33
CTOS SM**	23	13.6	146 max	78.7	49.9	33

CTOS 77M00 : Sealed Straight Backshell Receptacle for Tactical Cable

BACKSHELL MAIN USE :

To be used inside and outside a vehicle to connect CTOS receptacle to the electro-optic transceivers, in a non protected and humid area. Straight backshell to be used with a 1, 2, 4 fibers tactical cables inside or outside a vehicle. The rear part is made of an aluminum alloy shell with a cable retention clamp. Complete front and rear sealing. Possibility to add a multi channel connector at the other cable end. Cable/receptacle tensile strength : 100 daN (depending on cable performance).

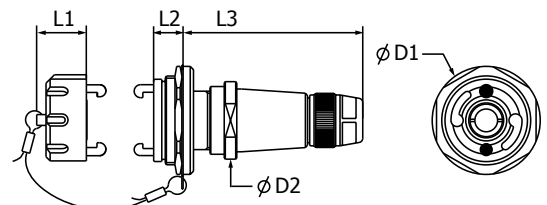

SERIES	L1	L2	L3	φD1	φD2
CTOS MM*	23	13.6	83	49.9	39
CTOS SM**	23	13.6	97	49.9	39

* MM : Multimode ** SM : Singlemode

CTOS 77C90 :
90° Backshell Receptacle for Tactical Cable

BACKSHELL MAIN USE :

To be used inside a vehicle or on a box to connect CTOS receptacle to the electro-optic transceivers, in non protected area, or when the rear space is too narrow. 90° backshell not sealed to be used with a 1, 2, 4 fiber tactical cable inside a vehicle. The rear part is made of 2 half shells molded in aluminum alloy. Backshell with reduced overall dimensions. Possibility to add a multi channel connector at the other cable end. Cable/receptacle tensile strength : 50 daN (depending on cable performance).

SERIES	L1	L2	L3	L4	L5	φD1
CTOS MM*	23	13.6	44	78.5	146 max	49.9
CTOS SM**	23	13.6	58	78.5	146 max	49.9

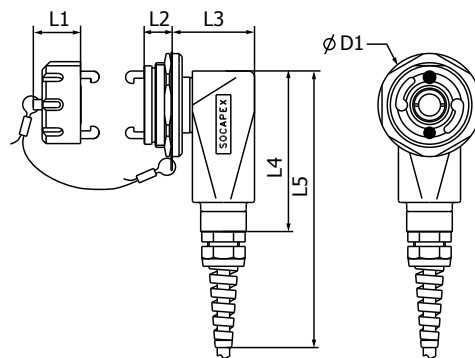

CTOS 77M90 :
Sealed 90° Backshell Receptacle for Tactical Cable

BACKSHELL MAIN USE :

To be used inside and outside a vehicle to connect CTOS receptacle to the electro-optic transceivers, in a non protected or humid area, or when the rear space is too narrow. 90° backshell to be used with a 2 or 4 fibers tactical cable outside a vehicle. Complete front and rear sealing. Backshell with reduced overall dimensions. Possibility to add a multi channel connector at the other cable end. Cable/receptacle tensile strength : 50 daN (depending on cable performance).

SERIES	L1	L2	L3	L5	φD1	φD2
CTOS MM*	23	13.6	64	87	49.9	39
CTOS SM**	23	13.6	78	87	49.9	39

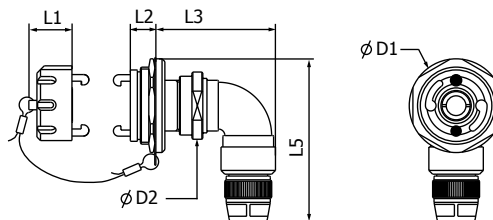

CTOS "JaM nut" Receptacle - Panel Cutout

CTOS JAM NUT RECEPTACLE SETTING :

- Screwing Jam Nut torque value : 40mN
- Screwing nut tip : 974-146039-90
- Panel thickness : 1.6mm to 3.5mm

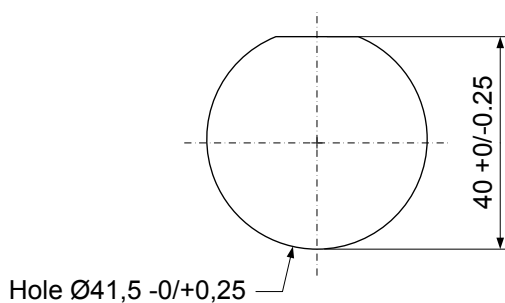

* MM : Multimode ** SM : Singlemode

CTOS 00/CTOL 00 "Square Flange" Receptacle rear mount

The square flange receptacle has to be mounted on to the vehicle panel. It provides the link between the inside electro-optic device and the outside optical link. The square flange receptacle receives the first CTOS plug of the outer link patchcord. The square flange type makes it possible to have a high density of receptacles on a panel. Easy panel cut off of 5 round holes. Fixation by 4 screws. - Front sealing ensured by a flat gasket. Electrical contact between panel receptacle and protective cap (EMI,CEM protection when cap is on). Protective cap attached to the panel or to the receptacle by a stainless steel rope.

CTOS 00P/CTOL 00P

Straight Backshell Receptacle for Pigtails

BACKSHELL MAIN USE :

To be used inside a vehicle or on a box to connect CTOS receptacle to the electro-optic transceivers, in a protected area. This rear part makes possible an easy cross connect output. Straight rear part to be used with 1, 2, 4, pigtails (2.8 mm single cable or duplex cable 2 x 3 ,2x 1.6). Each pigtail can be terminated with ST, SC, FC, duplex SC and MTRJ connectors. Pigtails tensile strength : 10 daN (depending on cable performance).

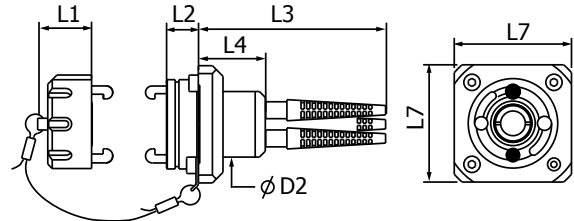

SERIES	L1	L2	L3	L4	L7	Ø D2
CTOS MM*	23	13.6	82	29	49.9	28
CTOS SM**	23	13.6	90.5	38.7	49.9	28
CTOL MM*	27	13.6	96	44	60	51
CTOL SM**	27	13.6	96	44	60	51

CTOS 00C00/CTOL 00C00

Straight Backshell Receptacle for Tactical Cable

BACKSHELL MAIN USE :

To be used inside a vehicle or on a box to connect CTOS receptacle to the electro-optic transceivers, in non protected area. Unsealed straight backshell to be used with 1 or 2 tactical cables (1,2 or 4 number of channels) inside a vehicle. The rear part is made of 2 half shells molded in aluminum alloy. Possibility to add a multi channel connector at the other cable end. Cable/receptacle tensile strength : 100 daN (depending on cable performances).

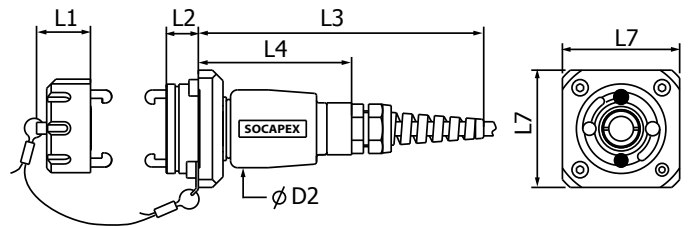

SERIES	L1	L2	L3	L4	L7	Ø D2
CTOS MM*	23	13.6	132 max	64.7	49.9	33
CTOS SM**	23	13.6	146 max	78.7	49.9	33
CTOL MM*	27	13.6	152 max	84	60	33
CTOL SM**	27	13.6	152 max	84	60	33

CTOS 00M00/CTOL 00M00

Sealed Straight Backshell Receptacle for Tactical Cable

BACKSHELL MAIN USE :

To be used inside and outside of a vehicle to connect CTOS receptacle to the electro-optic transceivers, in a non protected or humid area. Straight backshell to be used with a 1,2, 4 fibers tactical cable inside or outside a vehicle. The rear part is made of an aluminum alloy shell with bit of cable retention gland. Complete front and rear sealing. Possibility to add a multi channel connector at the other cable end. Cable/receptacle tensile strength : 100 daN (depending on cable performance).

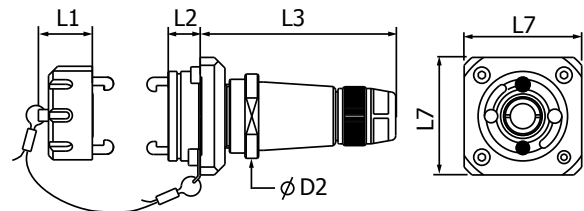

SERIES	L1	L2	L3	L7	Ø D2
CTOS MM*	23	13.6	83	49.9	39
CTOS SM**	23	13.6	97	49.9	39
CTOL MM*	27	13.6	102	60	39
CTOL SM**	27	13.6	102	60	39

* MM : Multimode ** SM : Singlemode

**CTOS 00C90/CTOL 00C90 :
90° Backshell Receptacle for Tactical Cable**

BACKSHELL MAIN USE :

To be used inside a vehicle or on a box to connect CTOL receptacle to the electro-optic transceivers, in a non protected area, or when the rear space is too narrow. Unsealed 90° backshell to be used with a 1, 2, 4, fibers tactical cable inside a vehicle. The rear part is made of 2 half shells molded in aluminum alloy. Backshell with reduced overall dimensions. Possibility to add a multi channel connector at the other cable end. Cable/receptacle tensile strength: 50 daN (depending on cable performance).

SERIES	L1	L2	L3	L5	L7	L6
CTOS MM*	23	13.6	44	78.5	49.9	146 max
CTOS SM**	23	13.6	58	78.5	49.9	146 max
CTOL MM*	27	13.6	63	78.5	60	146 max
CTOL SM**	27	13.6	63	78.5	60	146 max

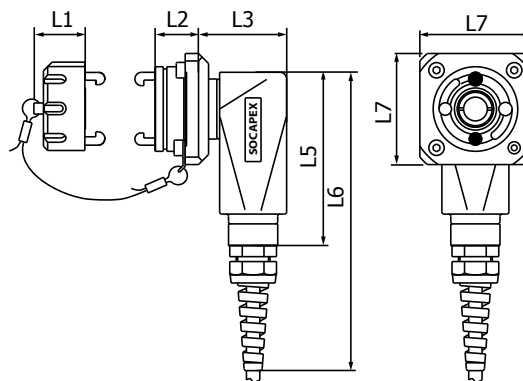

**CTOS 00M90/ CTOL 00M90
Sealed 90° Backshell Receptacle for Tactical Cable**

BACKSHELL MAIN USE :

To be used inside and outside a vehicle to connect CTOS receptacle to the electro-optic transceivers, in a non protected or humid area, or when the rear space is too narrow. 90° backshell to be used with a 1, 2, 4 fibers tactical cable inside or outside a vehicle. Complete front and rear sealing. Backshell with reduced overall dimensions. Possibility to add a multi channel connector at the other cable end. Cable/receptacle tensile strength: 50 daN (depending on cable performance).

SERIES	L1	L2	L3	L5	L7	∅D2
CTOS MM*	23	13.6	64	87	49.9	39
CTOS SM**	23	13.6	78	87	49.9	39
CTOL MM*	27	13.6	83	92	60	39
CTOL SM**	27	13.6	83	92	60	39

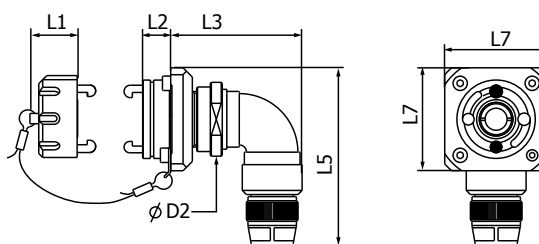

CTOS/CTOL «square flange» Receptacle - Panel Cutout

CTOS SQUARE FLANGE RECEPTACLE SETTING :

- Tightening torque screw M3x0.5 : 1.5mN
- Tightening torque screw M4x0.7 : 2.5mN

SERIES	L1	∅D1	∅D2	∅D3
CTOS	34.9	3.2	4.2	38.3
CTOL	42	3.2	4.2	38.3

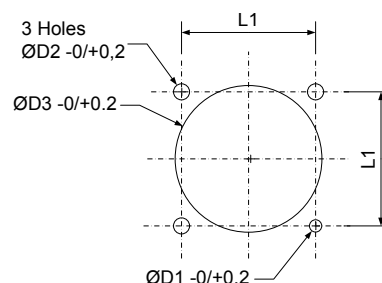

* MM : Multimode ** SM : Singlemode

How to order CTOS and CTOL piece part

HOW TO ORDER	CTOS CTOL	77 77	M00 M00	4 8	02 05	Z W	55X 70X	BPE BPE
<p>Series CTOS : Small optical field connector Stainless Steel Version CTOS-A : Small optical field connector Aluminium Version CTOL : Large optical field connector Stainless Steel Version</p>								
<p>Shell type 06 : Plug 77 : Jam nut receptacle (only for CTOS) 00 : Square flange receptacle</p>								
<p>Backshell For Plug M : Backshell For Plug</p>								
<p>Backshell For Receptacle P : Pigtails termination C00 : Straight backshell for tactical cable C90 : 90° backshell for tactical cable M00 : Sealed straight backshell for tactical cable M90 : Sealed 90° backshell for tactical cable</p>								
<p>Number of channels For CTOS : 1/2/4 For CTOL : 1/2/4/6/8 compatible CTOL 2S/4S compatible CTO</p>								
<p>Fiber 01 : Multimode 50/125 02 : Multimode 62.5/125 05 : Singlemode 9/125</p>								
<p>Wavelength For Multimode Y : 1300nm Z : 850/1300nm For Singlemode W : 1310/1550nm</p>								
<p>Cable See details on cable definition Example For pigtails cable : 28X For Tactical Cable : 55X</p>								
<p>Protective Cap BPF : Dust cap for Plug BPE : Dust cap for Jam nut receptacle BPP : Dust cap for Square flange</p>								

**How to order CTOS patchcord
CTOS/CTOL PLUG TO CTOS/CTOL PLUG**

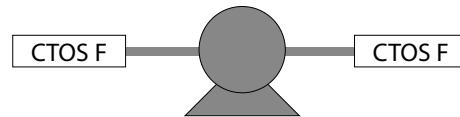

HOW TO ORDER	CTOS	L3	FF		2	01	Y	0600	55A	BPF
	CTOS		FF		2	01	Y	0600	55A	BPF
	CTOL		F00	M90	8	02	Z	1.50	70X	BPF/E
	CTOS		F77	C00	2	05	W	0020	60X	BPF/P
Series										
CTOS : Small optical field connector Stainless Steel Version										
CTOS-A : Small optical field connector Aluminium Version										
CTOL : Large optical field connector Stainless Steel Version										
Drum (Select The drum on page 26-28)										
__ : Disposable drum										
LX : Compact drum										
T0X : Tactical drum for CTOS										
T2X : Tactical drum for CTOL										
P01 : Trolley with composite drum for CTOS and CTOL										
Shell type										
FF : Plug to plug										
F00 : Plug to square flange receptacle										
F77 : Plug to jam nut receptacle										
Backshell (only for receptacle)										
C00 : straight backshell for tactical cable										
C90 : 90° backshell for tactical cable										
M00 : Sealed straight backshell for tactical cable										
M90 : Sealed 90° backshell for tactical cable										
Number of channels										
For CTOS : 1/2/4										
For CTOL : 1/2/4/6/8 compatible CTOL, 2S/4S compatible CTO										
Fiber										
01 : Multimode 50/125										
02 : Multimode 62.5/125										
05 : Singlemode 9/125										
Wavelength										
For Multimode : Z : 850/1300nm										
For Singlemode : W : 1310/1550nm										
Cable length										
X.XX : L<10m										
XXXX : L>10m										
Cable										
See details on cable definition										
Example										
For Tactical Cable : 55X										
Protective Cap										
BPF : Dust cap for plug to plug patchcord										
BPF/E : Dust cap for plug and jam nut receptacle										
BPF/P : Dust cap for plug and square flange receptacle										

How to order CTOS/CTOL patchcord
CTOS/CTOL connector to others type connectors

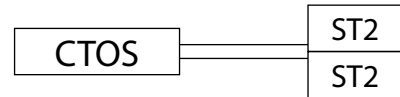

HOW TO ORDER	CTOS	00	M90	4	02	Z	2.50	70X	BPE	FC
	CTOS	F		2	01	Y	1.25	55A	BPF	SCD
	CTOL	77	00	4	05	W	0010	60X	BPE	FCA
Series										
CTOS : Small optical field connector Stainless Steel Version										
CTOS-A : Small optical field connector Aluminium Version										
CTOL : Large optical field connector Stainless Steel Version										
Shell type for first end										
F : Plug										
00 : Square flange receptacle										
77 : Jam nut receptacle (only for CTOS)										
Backshell (only for receptacle)										
P : Pigtailed termination										
C00 : straight backshell for tactical cable										
C90 : 90° backshell for tactical cable										
M00 : Sealed straight backshell for tactical cable										
M90 : Sealed 90° backshell for tactical cable										
Number of channels										
For CTOS : 1/2/4										
For CTOL : 1/2/4/6/8 compatible CTOL, 2S/4S compatible CTO										
Fiber										
01 : Multimode 50/125										
02 : Multimode 62.5/125										
05 : Singlemode 9/125										
Wavelength										
For Multimode : Z : 850/1300nm										
For Singlemode : W : 1310/1550nm										
Cable length										
X.XX : L<10m										
XXXX : L>10m										
Cable										
See details on cable definition										
Example : For Tactical Cable : 55X										
Protective Cap										
BPF : Dust cap for Plug										
BPE : Dust cap for Jam nut receptacle										
BPP : Dust cap for Square flange										
Patchcord other end connector										
STA : Startop (38999 series III with optical termini 29504, only MM)										
TVOP : TVOP (38999 series III with optical termini 2.5mm available MM and SM)										
AXOS : AXOS connector only MM										
ST/SC/SCD (duplex SC)/FC/LC/LCD (Duplex LC)/MHF (MTRJ femelle) : Telecom connector available in MM and SM										
SCA/FCA/LCA : Telecom connector with angle physical contact 8° only for SM										
For others connector consult us										

CTOS Shunt caps

This device is designed to test the electronic emitter and receiver as well as the optical receptacle and the link before the optical link deployment in the field.

The loop back is done by channel pairs: channel 1 with channel 2, channel 3 with channel 4.

CTOS receptacle protective shunt cap (BPPSA/BPESA)

The receptacle protective shunt cap is used to test the emitter, the receiver and the CTOS receptacle on a vehicle before using the link.

This shunt cap introduces a large insertion loss which is optical power budget dependent and has to be defined with the customer (generally 20 dB max).

The BPESA is dedicated to test the jam nut receptacle. It is delivered with a rope and a ring to be fixed under the hexagonal nut in order to replace the receptacle protective cap (see the drawing).

The BPPSA is dedicated to test square flange receptacle. It is delivered with a panel attachment cord and can replace the receptacle protective cap.

The BPBSA itself is equipped with a protective cap.

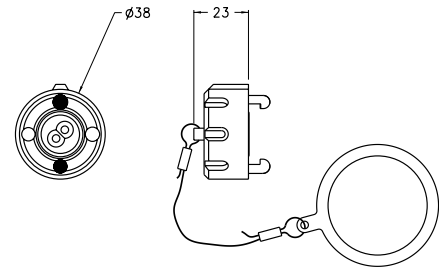

BPESA shunt cap

CTOS BSA

The BSA is a plug shunt cap with a low insertion loss, to test the plug to plug CTOSCTOL patchcord on a reel before the optical link is deployed.

The maximum insertion loss is fixed at 5 dB.

The BSA is equipped with a protective cap.

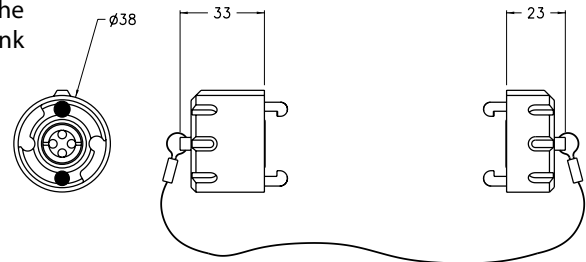

How to order CTOS shunt caps

HOW TO ORDER	CTOS CTOS	BPESA BSA	20 5
Series CTOS : Small optical field connector Stainless Steel Version CTOS-A : Small optical field connector Aluminium Version			
Shunt type BPESA : MM Jam nut receptacle attenuating shunt cap BPPSA : MM Square flange receptacle attenuating shunt cap BSA : MM Plug attenuating shunt cap with protective cap ? BSAR or BSU : MM plug and receptacle attenuating universal shunt cap BSAS : SM plug and receptacle attenuating shunt cap			
Insertion loss 20 : 20 db max for BPESA, BPPSA (fixed with MM fiber) 5 : 5db max for BSA, BSAR, BSAS (MM and SM fiber)			

Nota : For CTOL shunt caps consult us.

AXOS-E



This product offers a robust and protected optical connection in a small size design (o.d. 27 mm) and allows to establish a variable length daisy chain link in no time outdoor as well as indoor.

The beam diameter makes the connection insensitive to environmental contamination, temperature variations or humidity. The special design ensures an easy cleaning of the mechanical and optical connector parts.

Features

The Amphenol AXOS fiber optic expanded beam is a miniature hermaphroditic and a cost effective connector.

Technical description

- 1, 2 or 4 channel plugs and receptacles with protective caps (plastic)
- Hermaphroditic interface with rapid ramp coupling.
- Protective window to ensure an easy cleaning of the optical device.
- Moving coupling nut allows cleaning the front mechanical parts.
- Anticorrosion metal body with ergonomic protective rubber shell.
- Blind mateable by means of rubber shell guiding protuberances.
- Z : Insertion Loss : 0,8 dB typically; 1,5 dB max @ 1300 nm

(lasersource with single mode pigtail)

- Insertion Loss : 1,5 dB typically; 2 dB max @ 1300 nm
1,6 dB typically; 2,5 dB max @ 850 nm (DELSOURCE)
- Operational wavelength: 850 nm and 1300 nm.
- Fiber size: 50/125 and 62,5/125 μm .
- Cable type : 4 to 7 mm OD Tactical tight structure.
- Durability : 2500 mating cycles.
- Operating Temperature : -40°C, +85°C.
- Termination and Maintenance tool kits available.
- Drums and accessories available.

Applications

- Army, Navy and Airforce optical networks.
- Broadcasting.
- Federal emergency.
- Mining, geophysical.
- Temporary optical links.
- Industrial moving links.

Channels arrangements



2 Channels



4 Channels

AXOS-e : line drawings (dimensions in mm)

AXOS 06M : plug with protective cap (06M shown)

SERIES	L1	L2	L3	$\phi D1$
AXOS-e	36	133	108	27

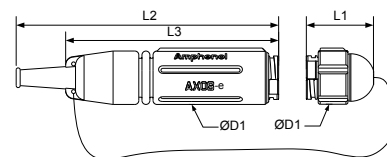

AXOS 00P : Square flange receptacle rear mount

SERIES	L1	L4	L5	L6	$\phi D1$	$\phi D2$
AXOS-e	36	55	13	35.5	27	23

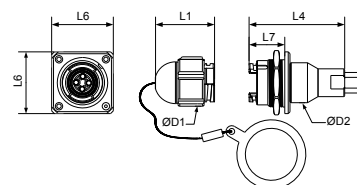

AXOS-77P : Square flange receptacle Rear mount 77p - 90° BACKSHELL

SERIES	L1	L4	L5	L6	L8	$\phi D1$	$\phi D2$
AXOS-e	36	70 max	13	35.5	40	27	23

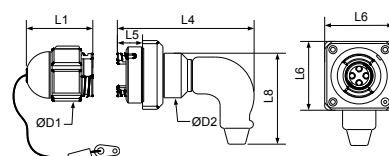

AXOS 77p JAM nut receptacle rear mount

SERIES	L1	L4	L7	φD1	φD2	φD3
AXOS-e	36	55	20.5	27	23	35.5

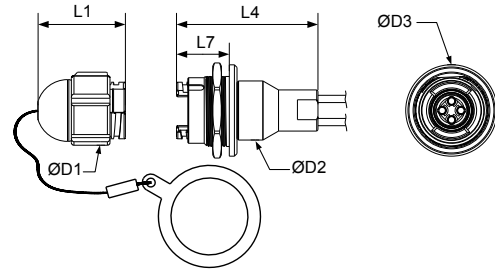

AXOS 00p JAM nut receptacle rear mount 90° BACKSHELL

SERIES	L1	L4	L7	L8	□D1	□D2	□D3
AXOS-e	36	70 max	20,5	40	27	23	35.5

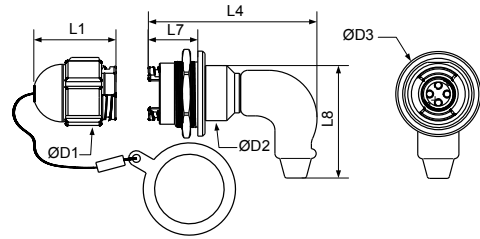

AXOS - Panel Cutout

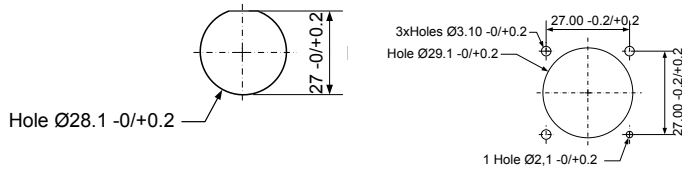

How to order AXOS-e piece part

HOW TO ORDER	AXOS	00	M90	4	02	Z	55A	BPP
	AXOS	06	M	2	01	Z	55A	BPF
	AXOS	77	P00	4	02	Z	28X	BPE
Series AXOS :								
Shell type 06 : Plug 77 : Jam nut receptacle 75 : Jam nut receptacle with CTOS dimension 00 : Square flange receptacle								
Backshell For Plug M : Backshell For Plug								
Backshell For Receptacle P : Pigtails termination C00 : Straight backshell for tactical cable C90 : 90° backshell for tactical cable M00 : Sealed straight backshell for tactical cable M90 : Sealed 90° backshell for tactical cable								
Number of channels 1/2/4								
Fiber 01 : Multimode 50/125 02 : Multimode 62.5/125								
Wavelength Z : 850/1300nm								
Cable See details on cable definition Example For pigtails cable : 28X For Tactical Cable : 55X								
Protective Cap BPF : Dust cap for Plug BPE : Dust cap for Jam nut receptacle BPP : Dust cap for Square flange Metallic protective cap (consult us)								

**How to order AXOS-e Patchcord
AXOS-e plug to AXOS-e plug**

HOW TO ORDER	AXOS		FF		2	01	Y	0600	55A	BPF
	AXOS	L3	FF		2	01	Y	0600	55A	BPF
	AXOS		F00	M90	4	02	Z	1.50	70X	BPF/E
	AXOS		F77	C00	2	05	W	0020	60X	BPF/P
Series										
AXOS :										
Drum (Select The drum on page 26-28)										
__ : Thrownable drum										
LX : Compact drum										
TOX : Tactical drum										
P01 : Trolley with composite drum										
Shell type										
FF : Plug to plug										
F00 : Plug to square flange receptacle										
F77 : Plug to jam nut receptacle										
Backshell (only for receptacle)										
C00 : straight backshell for tactical cable										
C90 : 90° backshell for tactical cable										
M00 : Sealed straight backshell for tactical cable										
M90 : Sealed 90° backshell for tactical cable										
Number of channels										
1/2/4										
Fiber										
01 : Multimode 50/125										
02 : Multimode 62.5/125										
Wavelength										
Z : 850/1300nm										
Cable length										
X.XX : L<10m										
XXXX : L>10m										
Cable										
See details on cable definition										
Example										
For Tactical Cable : 55X										
Protective Cap										
BPF : Dust cap for plug to plug patchcord										
BPF/E : Dust cap for plug and jam nut receptacle										
BPF/P : Dust cap for plug and square flange receptacle										
Metallic protective cap (consult us)										

How to order AXOS-e Patchcord AXOS-e connector to others type connectors

HOW TO ORDER	AXOS	00	M90	4	02	Z	2.50	55X	BPP	FC
	AXOS	F		2	01	Z	1.25	55A	BPF	SCD
	AXOS	77	P00	4	01	Z	3.50	15X	BPE	LC
Series										
AXOS :										
Shell type for first end										
F : Plug										
00 : Square flange receptacle										
77 : Jam nut receptacle										
Backshell (only for receptacle)										
P : Pigtailed termination										
C00 : straight backshell for tactical cable										
C90 : 90° backshell for tactical cable										
M00 : Sealed straight backshell for tactical cable										
M90 : Sealed 90° backshell for tactical cable										
Number of channels										
1/2/4										
Fiber										
01 : Multimode 50/125										
02 : Multimode 62.5/125										
Wavelength										
Z : 850/1300nm										
Cable length										
X.XX : L<10m										
XXXX : L>10m										
Cable										
See details on cable definition										
Example : For Tactical Cable : 55X										
Protective Cap										
BPF : Dust cap for Plug										
BPE : Dust cap for Jam nut receptacle										
BPP : Dust cap for Square flange										
Metallic protective cap (consult us)										
Patchcord other end connector										
STA : Startop (38999 series III with optical termini 29504 only MM)										
TVOP : TVOP (38999 series III with optical termini 2.5mm only MM)										
CTOS : CTOS connector only MM										
HMA : HMA two connector only MM										
EUROCOM : EUROCOM II connector only MM										
ST/SC/SCD (duplex SC)/FC/LC/LCD (Duplex LC)/MHF (MTRJ female)										
For others connector consult us										

TACBEAM



Amphenol introduces the TACBeam Series into the Harsh Environment product portfolio. This legacy hermaphroditic fiber optic lens connector facilitates the inter-connection of multiple identical fiber optic cable assemblies known as daisy chaining, thus eliminating the need for polarising the assemblies and the use of in-line adapters. Lens technology is less vulnerable to mud, dirt and other contaminants than the traditional physical contact technology. This allows rapid and reliable deployment of assemblies in extreme environments. The Connector is available in 1 to 4 way configurations for multimode fibers at both 850 and 1300nm applications and is inter-mateable/interchangeable with other manufacturers equivalent products.

The standard connector components are aluminium with a long life Hard Black anodise finish with the coupling ring featuring a protective "rubber" overmould. The connector has been designed for both factory and field termination directly onto standard tactical fiber optic cable without specialist lens termination tooling. The connector construction allows for both first line field repairs and return to base overhauls of both the connector and the Lens assembly.

Features

- Proven Expanded Beam Technology
- M83526/20 & 21 Compliant
- IL Typ. 0.7db Max 2.5dB MM/SM
- Field cleanable and repairable
- Waterproof

Applications

- Military
- Outside broadcast
- Industrial/Geophysical

Materials

- Aluminum, Olive Drab or Black
- Brass
- Marine Bronze
- Stainless Steel, 303 or 316

Channels arrangements



2 Channels



4 Channels

TACBeam plug (dimensions in mm)

SERIES	L1	L2	L3	φD1	φD2
TACBeam	140	83	25	27.2	3-7.5

TACBeam jam nut receptacle

SERIES	L1	L2	L3	L4	L5	φD1	φD2
TACBeam	32.2	14.4	18.5	25	3-6.5	26.7	37

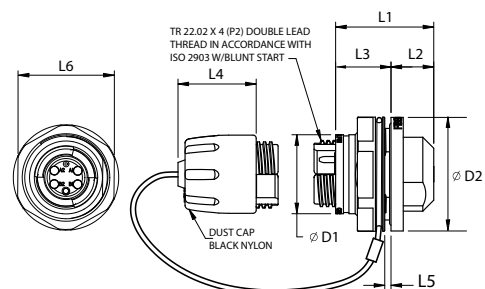
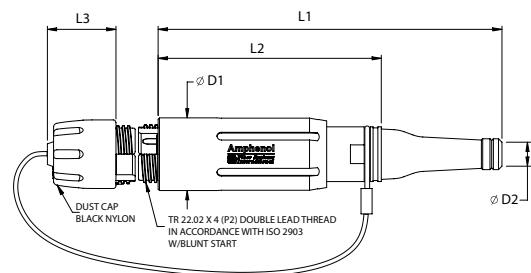

TACBeam Strain Relief Jam Nut Receptacle

SERIES	L1	L2	L3	L4	L5	L6	φD1	φD2
TACBeam	114	66	18.5	25	3-6.5	34	26.7	3-7.5

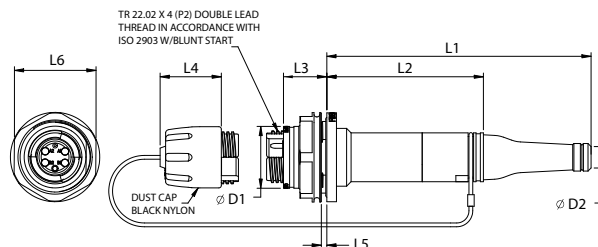

TACBeam Square Flange Receptacle

SERIES	L1	L2	L3	φD1	φD2
TACBeam	18.5	25	37	26.7	3.5

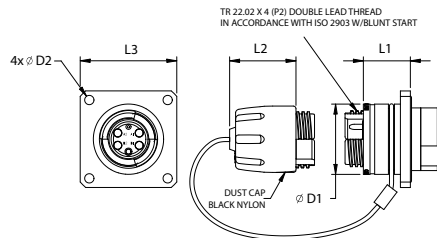

TACBeam Strain Relief Square Flange Receptacle

SERIES	L1	L2	L3	L4	L5	φD1	φD2	φD3
TACBeam	114	66	18.5	25	37	26.7	3-7.5	3.5

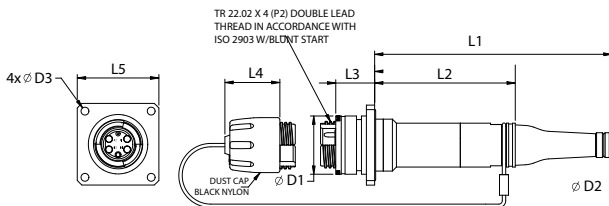

TACBeam Jam Nut Panel Cutout

SERIES	L1	φD1
TACBeam	30	28

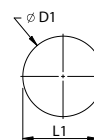

TACBeam Square Flange Panel Cutout

SERIES	L1	φD1	φD2
TACBeam	30	3.2	24.5

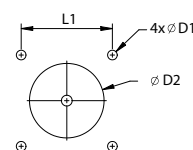

How to order TACBeam piece part

HOW TO ORDER	TACBeam	06	2	-ZA	-0850-1300	3
	TACBeam	07	4	-ZB	-0850-1300	
Series : TACBeam	TACBeam					
Shell type :	06 : Plug 07 : Jam nut receptacle 00 : Square Flange receptacle					
Number of Channels :	2 : 2 CH 4 : 4 CH					
Finish :	8 : Olive Drab Aluminum 3 : Black Aluminum A : MARINE BRONZE B : 306 BRASS C : 303 STAINLESS STEEL F : 316 STAINLESS STEEL					
Wavelength :	1 : 0850/1300 (Multimode) 2 : 1310 (Singlemode) 3 : 1550 (Singlemode) 4 : 1310/1550 (Singlemode)					
Cable Variant :	3 : 3-4.5mm 4 : 4.5-6mm 5 : 6-7.5mm					

How to order TACBeam patchcord : TACBeam plug to TACBeam plug

HOW TO ORDER	TACB	L3	FF	3	M00	4	01	Z	0600	55A	BPF
Series :	TACBeam										
Drum (Select The drum on drum select guide)	___ : Throwable drum LX : Compact drum TOX : Tactical drum										
Shell type :	FF : Plug to plug F77 : Plug to jam nut receptacle F00 : Plug to square flange receptacle										
Finish :	8 : Olive Drab Aluminum 3 : Black Aluminum A : MARINE BRONZE B : 306 BRASS C : 303 STAINLESS STEEL F : 316 STAINLESS STEEL										
Backshell (only for receptacle)	M00 : Sealed straight backshell for tactical cable										
Number of channels :	2 : 2 CH 4 : 4 CH										
Fiber :	01 : Multimode 50/125 02 : Multimode 62.5/125 09 : Singlemode 9/125										
Wavelength :	Z : 0850/1300 (Multimode) W : 1310/1550 (Singlemode)										
Cable length :	X.XX : L<10m XXXX : L>10m										
Cable :	See details on cable definition, example For Tactical Cable : 55X										
Protective Cap :	BPF : Dust cap for plug to plug patchcord BPF/E : Dust cap for plug and jam nut receptacle										

How to order TACBeam patchcord : TACBeam connector to others type connectors

HOW TO ORDER	TACB TACB	00 F	ZA	M00	4 2	02 01	Z Z	2.50 1.25	55X 55A	BPP BPF	FC SCD
Series :	TACBeam										
Shell type for first end :	F : Plug 77 : Jam nut receptacle 00 : Square flange receptacle										
Finish :	8 : Olive Drab Aluminum 3 : Black Aluminum A : MARINE BRONZE B : 306 BRASS C : 303 STAINLESS STEEL F : 316 STAINLESS STEEL										
Backshell (only for receptacle)	P : Pigtailes termination M00 : Sealed straight backshell for tactical cable										
Number of channels :	2 : 2 CH 4 : 4 CH										
Fiber :	01 : Multimode 50/125 02 : Multimode 62.5/125 09 : Singlemode 9/125										
Wavelength :	Z : 0850/1300 (Multimode) W : 1310/1550 (Singlemode)										
Cable length :	X.XX : L<10m XXXX : L>10m										
Cable :	See details on cable definition, example : For Tactical Cable : 55X										
Protective Cap :	BPF : Dust cap for Plug BPE : Dust cap for Jam nut receptacle										
Patchcord other end connector :	CTOS : CTOS connector AXOS : AXOS-e connector EU2 : EUROCOM connector STA : Startop (38999 series III with optical termini 29504 only MM) TVOP : TVOP (38999 series III with optical termini 2.5mm only MM) ST/SC/SCD (duplex SC)/FC/LC/LCD (Duplex LC)/MHF (MTRJ female)										

Eurocom II



Amphenol provides cable assembly for EUROCOM II. The connector complies with the EUROCOM II Basic Parameters D/1 IB5, connector Type 2, and with the Specification TL 6020-0001 of the German Office of Military Engineering and Purchasing.

The hermaphrodite expanded beam connector is suitable for mobile applications under rough environmental conditions. Typically, the connector can be used at both cable ends. This special type "Line Connector" is mainly used for both connecting mobile cables one with another, and for connecting mobile cables to flange connectors at fix or mobile stations, to be locked or unlocked by a simple twist action.

Applications

- Military

Channels arrangements



2 Channels

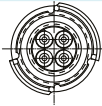

4 Channels

Eurocom : line drawings (dimensions in mm) Eurocom II : plug 06

SERIES	L1	L2	φD1
EUROCOM II	275	253	58

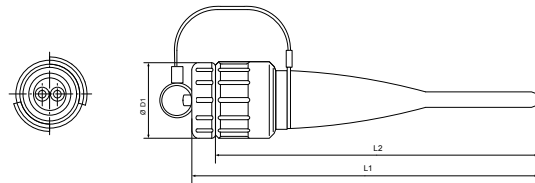

Eurocom II : jam nut receptacle Straight BACKSHELL 07S

SERIES	L1	L2	L3
EUROCOM II	18	3max	130

SERIES	φD1	φD2	φD3	φD4	φD5
EUROCOM II	52	26	43	45.5	48.5

SERIES	φD6	φD7	φD8
EUROCOM II	4.2	60	70

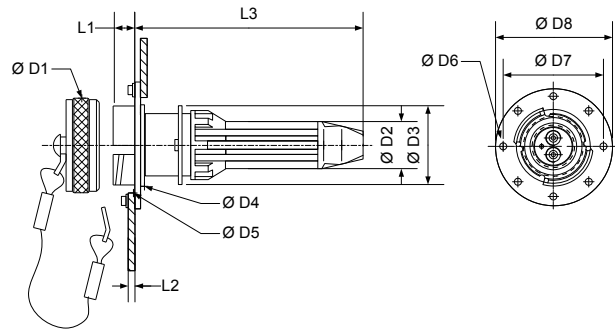

Eurocom II : jam nut receptacle right angle backshell 07a

SERIES	L1	L2	L3	L4	L5
EUROCOM II	18	3max	102	93	65

SERIES	φD1	φD2	φD3	φD4	φD5
EUROCOM II	52	27	45.5	48.5	18

SERIES	φD6	φD7	φD8
EUROCOM II	4.2	60	70

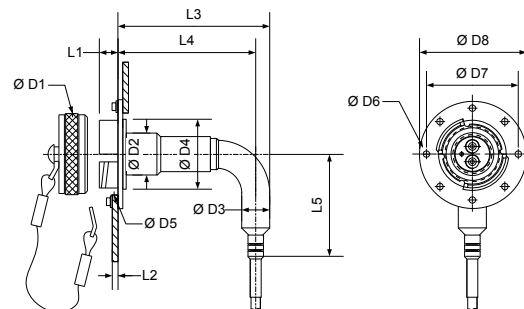

How to order eurocom ii patchcord EUROCOM II plug to EUROCOM II plug

HOW TO ORDER	EU2 EU2	L3	FF F77	M00	2 4	01 02	Z Z	0600 5.00	55A 55A	BPF BPF/E
Series EUROCOM II										
Drum (Select The drum on page 26-28) __ : Throwable drum LX : Compact drum TOX : Tactical drum P01 : Trolley with composite drum										
Shell type : FF : Plug to plug F77 : Plug to jam nut receptacle										
Backshell (only for receptacle) C00 : straight backshell for tactical cable C90 : 90° backshell for tactical cable M00 : Sealed (?)straight backshell for tactical cable M90 : Sealed (?) 90° backshell for tactical cable										
Number of channels 2/4										
Fiber 01 : Multimode 50/125 02 : Multimode 62.5/125 Wavelength : Z : 850/1300nm										
Cable length X.XX : L<10m XXXX : L>10m										
Cable See details on cable definition Example For Tactical Cable : 55X										
Protective Cap BPF : Dust cap for plug to plug patchcord BPF/E : Dust cap for plug and jam nut receptacle										

How to order EUROCOM II patchcord EUROCOM II two connector to others type connectors

HOW TO ORDER	EU2	00	M90	4	02	Z	2.50	55X	BPP	FC
	EU2	F		2	01	Z	1.25	55A	BPF	SCD
	EU2	77	P00	4	01	Z	3.50	15X	BPE	LC
Series : EUROCOM II										
Shell type for first end F : Plug 77 : Jam nut receptacle										
Backshell (only for receptacle) P : Pigtailes termination C00 : straight backshell for tactical cable C90 : 90° backshell for tactical cable M00 : Sealed straight backshell for tactical cable M90 : Sealed 90° backshell for tactical cable										
Number of channels 2/4										
Fiber 01 : Multimode 50/125 02 : Multimode 62.5/125										
Wavelength Z : 850/1300nm										
Cable length X.XX : L<10m XXXX : L>10m										
Cable See details on cable definition Example : For Tactical Cable : 55X										
Protective Cap BPF : Dust cap for Plug BPE : Dust cap for Jam nut receptacle										
Patchcord other end connector CTOS : CTOS connector AXOS : AXOS connector only MM STA : Startop (38999 series III with optical termini 29504 only MM) TVOP : TVOP (38999 series III with optical termini 2.5mm only MM) ST/SC/SCD (duplex SC)/FC/LC/LCD (Duplex LC)/MHF (MTRJ female) For others connector consult us										

Tactical Cable Drums



Amphenol offers a wide range of tactical cable drums designed to cater for deployable harsh environment optical links. Drums are available in a variety of applications, sizes, materials, accessories, and for various diameters and lengths of cable.

Applications

- Army battlefields
- Off-Shore
- Very harsh environments

Tactical Drum

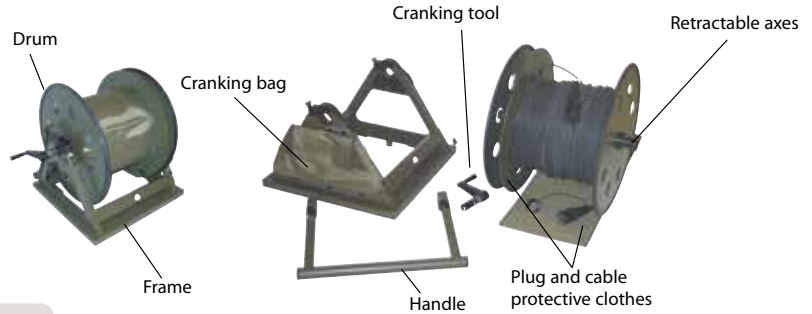

Tactical drum dimensions

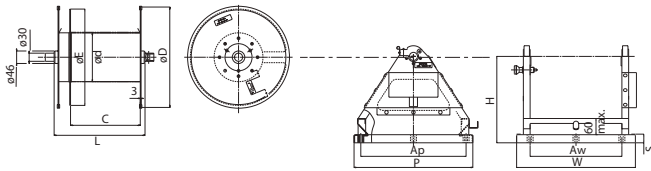

Trolley + composite trolley drum



Trolley dimensions

Storage dimensions

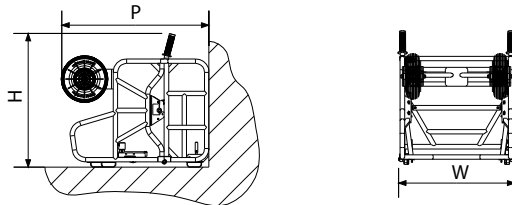

Using conditions

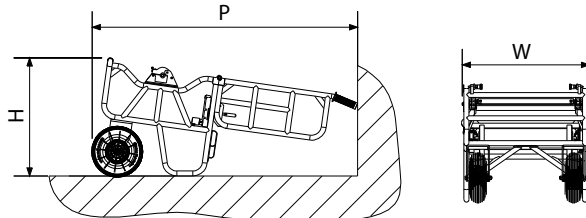

Composite trolley drum dimensions

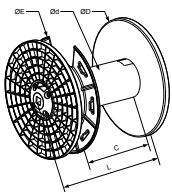

Tactical Cable drums dimensions

Compatible connectors with drum type T0X : CTOS, CTOS-A, AXOS, HMA two

Compatible connectors with drum type T2X : CTOL, EUROCOM II

Applications			OPTICAL LINKS						
Drum types			T05/25	T01/21	T03/23	T04/24	T07/27	P01	
DRUMS	Overall Dimensions (mm)	C	255/235	257/237	257/237	257/237	570/550	315	
		L	335	335	335	335	650	476	
		D	280	370	420	550	550	482	
E		270	355	405	535	535	476		
d		140	180	180	180	180	158		
	Plug compartment wide l		40/60	40/60	40/60	40/60	40/60	85	
	WEIGHT (kg) without cable		3,4	4,5	5,5	8	19	6,5	
FRAME	Trolley (with drum axel)							storage	using
	Overall Dimensions (mm)	W	440	440	440	440	755	650	650
		H	255	255	255	320	320	730	615
		P	440	440	440	440	440	820	1355
		S	25	25	25	30	30		
WEIGHT (kg)		4	6,65	6,65	7,65	12	17,3		
ACCESSORIES	Cranking tool		●	●	●	●	●	●	
	Handle		●	●	●	●	●	●	
	Inner separation for 2 patchcords								
	Crank bag		●	●	●	●	●	●	
	Plug & cable protec. clothes		●	●	●	●	●	●	
SHELLS FINISH			Nato green/ Black	Nato green/ Black	Nato green/ Black	Nato green/ Black	Nato green/ Black	RAL 6021 Green	
RUGGEDIZED VERSION	Standart		*	*	*	*	*		
	Option			**	**			**	

		TACTICAL DRUM CAPACITY in meters										
Cable diameter in mm	Drum Type	3,4	3,8	4,5	5	5,5	6	6,1	6,3	6,5	7	7,5
		T05		500	400	290	250	200	170	160	155	145
T01		955	780	555	460	380	320	310	290	275	240	210
T03		1350	1100	780	650	550	450	430	405	400	330	300
T00		1600	1300	925	750	620	530	510	480	450	390	345
T04		2550	2050	1470	1200	1000	850	810	760	750	650	550
T07		5660	4600	3260	2650	2200	1900	1795	1685	1600	1400	1200
T25		450	365	265	220	180	155	150	140	135	115	100
T21		880	710	510	420	350	295	285	270	255	220	195
T23		1240	1000	720	585	485	420	400	375	350	305	270
T20		1470	1200	850	700	580	485	470	445	420	360	315
T24		2360	1900	1360	1100	920	770	750	700	660	570	500
T27		5465	4400	3150	2560	2150	1800	1735	1630	1550	1330	1150
P01		2500	2000	1400	1100	1000	800	740	695	660	600	500
T13		1030	1030	600	485	400	340	330	310	290	255	220

Compact Drums



Amphenol offers a wide range of compact cable drums designed to cater for deployable harsh environment optical links. Drums are available in a variety of applications, sizes, materials, accessories, and for various diameters and lengths of cable.



Drum type LX

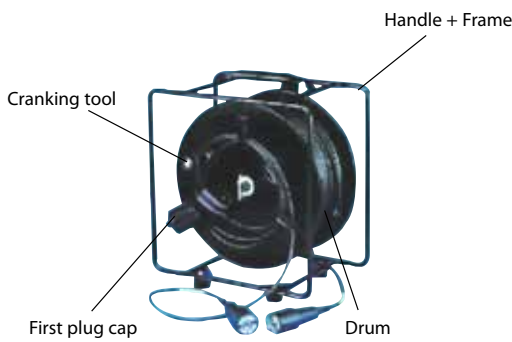

Applications

- Army battlefields
- Off-shore
- Industrial

Drum type D

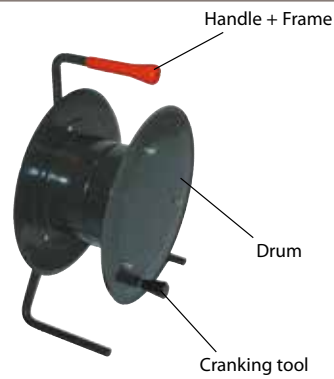

Applications

- Industrial

Type L2, L3, L34, L36 drums

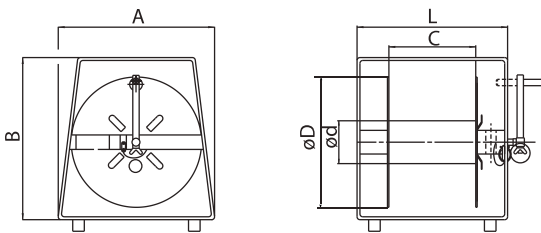

Type D

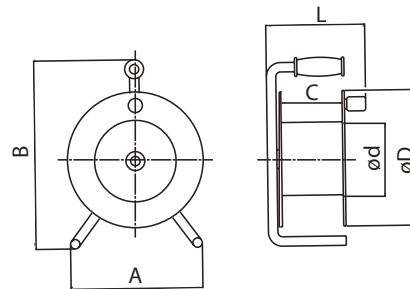

Type L1

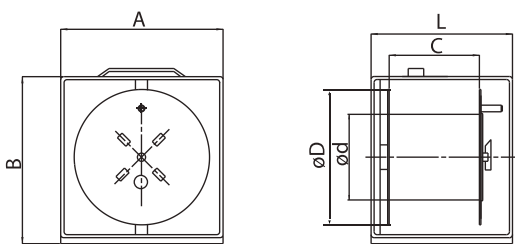

Compact drums dimensions

Compatible connectors with drum type LX and GX : CTOS, CTOSA, AXOS, HMA, CTOL, Eurocom II
Compatible connectors with drum type D : CTOS, CTOSA, CTOL, AXOS, HMA two

Applications			OPTICAL LINKS							
Drum types			L1	L2	L3	L34	L36	D	G2	GS
DRUMS + FRAME (integrated)	OVERALL DIMENSIONS (mm)	C	125	150	300	450	600	130	125	260
		L	230	350	500	650	800	200	?	410
		D	320	450	450	450	450	288	490	495
		d	90	230	230	230	230	155	160	300
		A	360	520	520	520	520	280	?	420
		B	400	540	540	540	540	400	605	590
	Weight		6.25	9.75	11.25	13	14.5	4	?	?
ACCESSORIES	CRANKING TOOLS (integrated)		●	●	●	●	●	●	●	●
	HANDLE + FRAME		●	●	●	●	●	●	●	●
	2 ELASTIC BELTS (integrated)							●	●	●
	INNER CABLE PROTECT CLOTH			●	●	●	●	no	no	no
	OUTER CABLE PROTECT CLOTH			●	●	●	●	no	no	option
	FIRST PLUG BAG		metallic can	●	●	●	●	no	no	no
SHELLS FINISH (*RAL 6021 Green)			green */ black	green */ black	green */ black	green */ black	green */ black	green	green	bare stainless steel

		COMPACT DRUM CAPACITY in meters										
Drum Type	Cable diameter in mm	3.4	3.8	4.5	5	5.5	6	6.1	6.3	6.5	7	7.5
		D	250	205	150	120	100	86	83	80	75	65
L1	385	300	225	180	150	130	125	120	110	95	85	
L2	835	700	485	400	330	280	270	255	240	210	180	
G2	970	780	560	455	380	320	310	290	275	235	205	
GS	1525	1230	890	725	600	510	494	465	440	380	335	
L3	1670	1350	970	800	660	560	540	510	480	420	370	
L34	2500	2030	1450	1200	1000	850	810	760	720	620	550	
L36	3340	2700	1940	1600	1300	1100	1075	1010	950	830	730	

Tactical Cable

COMPANY		OCC				NEXANS				SPECTRA STRIP			
Number of fibers		2	4	6	8	1	2-4	6	8	1	2-4	6	8
Cable diameter mm (in)		5 (0,2)	5,5 (0,22)	6,0 (0,24)	6,5 (0,26)	??6 (0,24)	5.4 (0,21)	6.1 (0,24)	6.3 (0,25)	5.5 (0,22)			
Cable weight Kg/km (lb/1,000)		23 (15)	28 (19)	28 (19)	38 (26)	26 (18)	25 (17)	32 (22)	35 (24)	(2-4 core typically) 25 (17)			
Reinforcing protection		aramid yarn				aramid yarn				aramid yarn			
Outside jacket		polyurethan				polyurethan				spectraloy			
Fiber minimum bandwidth	Multimode 850nm (Mhz.km)	200 (62.5/125)				500 (50/125) 200 (62.5/125)				200 (50/125) 400 (62.5/125)			
	Multimode 1310nm (Mhz.km)	500 (62.5/125)				800 (50/125) 500 (62.5/125)				400 (50/125) 600 (62.5/125)			
	Singlemode 1310nm (Mhz.km)	-				-				3.5			
	Singlemode 1550nm (Mhz.km)	-				-				18			
Fiber maximal attenuation	Multimode 850nm (Mhz.km)	3 (62.5/125)				3.5				3.5			
	Multimode 1310nm (Mhz.km)	1 (62.5/125)				1.5				1.5			
	Singlemode 1310nm (Mhz.km)	-				0,42				0,45			
	Singlemode 1550nm (Mhz.km)	-				0,28				0,3			
Temperature range	Storage	-70°C/+85°C (-94°F/+185°F)											
	Operating	-70°C/+85°C (-94°F/+185°F)				-40°C/+70°C (-94°F/+185°F)				-70°C/+85°C (-94°F/+185°F)			
Minimum bending radius mm (in)		8 X OD cable				60 (2,36)	50 (1,97)			10 X OD cable			
Maximum ten- sile strength	Short term N (lbs. f)	1800 (405)				(IEC 794 1E1) 2200 (495)				(2-4 core typically) (60- 1 part.3 cl.15.1) 2000 (450)			
	Operating N (lbs. f)	600 (135)				1300 (292)				(2-4 core typically) 2600			
Crush resistance N/cm (lbs/in)		(EIA 455 41) 440				(IEC 794 1E3) 300 (171)				(2-4 core typically) (IEC 60794-11&2) 1200 (685)			
Impact resistance (1J impact)		(EIA 455 25) 200				(IEC 794 1E4) 100				100 min			
Torsion/torque		TIA/EIA-455-104 2000 cycles				(IEC 794 1E8) 30000 cycles				(2-4 core tipycally) (IEC 60794-1-1) 1000 cycles			

Tactical cables with aramid yarn reinforcing protection

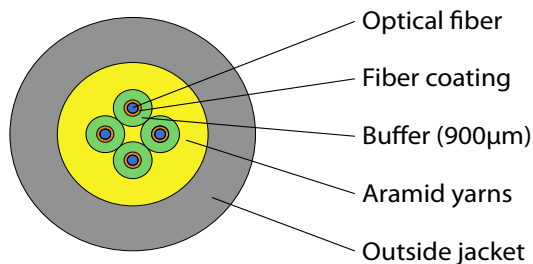

Technical information given by the supplier

FTOS : Flexible Tactical Optical Splice



This product allows you to easily repair tactical cables on the field with no epoxy handling. The special splice shell restores all the functions of the cable like tensile strength and flexibility crush resistance. The repaired cable can be unrolled on a reel as well as before repair. The FTOS reconstitutes the optical channels with low insertion loss.

Features

The Amphenol FTOS is a flexible field termination butt coupled fiber optical splice for tactical optical cables. It can be used for quick and durable indoor and external cable repairs. After the repair the cable can be rolled back on the reel.

FTOS is used to maintain CTOS connectors by splicing CTOS pigtails on the tactical cable of the harness.

Applications

- Tactical cable repair
- CTOS harness maintenance for Army, Navy and Airforce optical.
- Small size (o.d. 25 mm, length 400 mm) butt coupled splice
- 2 and 4 channel splice
- Flexibility : minimum bend radius : 120 mm
- Tensile strength between splice and cable : 150 daN
- Water resistant
- Operating Temperature : - 40°C; + 85°C

Performances

- Multimode typical insertion loss : 0,5 dB @ 850 nm and 1300 nm singlemode typical insertion loss: 0,5 dB, return loss : - 30 dB @ 1300 nm
- FTOS tool and consumable kits available

FTOS: dimensions

SERIES	L1	φD1	φD2
FTOS	400	21	25

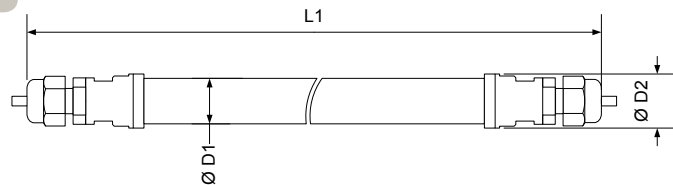

How to order FTOS piece part

HOW TO ORDER	FTOS FTOS	MM SM	2V 4V	55 60	Q05 Q05	BP BP
Series : FTOS						
Shell type :						
MM : multimode (50/125 or 62,5/125)						
SM : singlemode (9/125)						
Number of Channels :						
2V : 2 channels						
4V : 4 channels						
Cable outer diameter :						
55 : for 5,5 mm O.D.						
60 : for 6 mm O.D.						
Q05 : Number of splices per pieces part kit						
BP : Bulk pack (packaging)						



RES-GMC with Expanded Beam technology Military Ethernet Media Converter

For Harsh Environment - Fully MIL-STD compliant

Amphenol's RES-GMC is a MIL-STD rugged, unmanaged-military-grade security gateway, offering up to 2 Gigabit security gateways per device for unidirectional and data diodes solution for total isolation between two network with different security classification. The unit supports PoE on 2 ports (IEEE802.3af and IEEE802.3at).

Developed for military and harsh environment applications, the RES-GMC features mechanical packaging enhancements designed for MIL-STD-810F airborne and ground environmental compliance and high reliability.

The unit has been especially hardened to improve ingress, impact, and shock/vibration protection, as well as eliminate all moving parts through passive cooling, and interface through sealed MIL-D-38999 circular connectors.

Leveraging best-in-class switching technology, the RES-GMC series serves as a robust solution to extend your Tactical Gigabit Ethernet network connectivity of up to 120Km over fiber. Compact in size, the RES-GMC is particularly useful for remote and space-constrained locations either on ground vehicle environments or airborne.

Military applications

- Data acquisition & transmission
- Battlefield communication C4ISR
- Rugged Networks
- Combat vehicles
- Avionic & shipboard systems

Key features

■ Ethernet ports

- 10/100/1000 Base TX to 100/1000 Base FX-(MM/SM) Media converter (WDM - Optional)
- Up to 2 x 10/100/1000Base-TX and up to 2 x 100/1000 Base FX

■ Networking

- Full wire-speed forwarding rate
- Option for Up to 2 ports PoE - IEEE802.3af, IEEE802.3at
- Store-and-forward or Pass through mechanism
- Auto MDI-II, MDI-X, FDX, HDX, Flow control
- Auto-negotiation and fixed settings via DIP switch
- Jumbo frame support
- Link loss forwarding mechanism

■ Connectors

- MIL-D-38999 (Power & Ethernet signals)
- Power connector type: D38999/24WA98PA
- LAN connector type: RJFTV
- Fiber connector type: CTOS 77 PC or TAC BEAM EB 4H 8000
- Protective cap over each connector

■ Chassis

- Low profile rugged aluminium extrusion
- Conductively cooled w/custom internal heat-sinks
- Ingress protection against sand, dust and moisture
- Anodize coating, MIL-A-8625, Type II, Class 2

■ Standards

- MIL-STD-1275, MIL-STD-704A, MIL-STD-461E,
- MIL-STD-810F GM, IP67/68

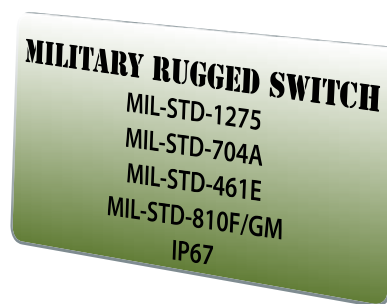

Product specifications

Performance

- 26.8 Mpps wire speed forwarding rate
- 2 Gbps maximum forwarding bandwidth
- 4K MAC address
- 2 LED indication (Speed, Link/Activity) per port
- Wire-speed reception and transmission

Standards compliance

- IEEE 802.3, 10 Mbps 10BASE-T (Ethernet)
- IEEE 802.3u, 100 BASE-TX 100 Mbps (Fast Ethernet)
- IEEE 802.3ab, 1000Base-TX
- IEEE 802.3z, 1000Base-FX Gigabit
- IEEE 802.3x Flow control

Power

- MIL-STD-1275B & MIL-STD-704A Surge and Spike protection
- Voltage input: 24Vdc nominal (18-36V)
- Power consumption: 2.8W typical
- Chassis grounding

Electromagnetic

- MIL-STD-461E Electromagnetic compatibility
- CE-102, CS-114, CS-115, CS-116, RE-102, RS-103

Environmental : shock/vibration/humidity

- MIL-STD-810F, 501.4I, 501.4II, 502.4I, 502.4II, 507.4, 500.4II, 514, 516I, 516VI, 514.5, 512.4
- IP67/68

Physical

- Dimensions: 169mm (L) x 149 (W) x 65(H), including connectors & hardware
- Weight: 1.260 kg

Installation

- Set of Four 4x4.5 mounting holes on bottom for mounting to any flat surface.
- Carrying handles - Optional

Cooling

- No moving parts. Passive cooling

Operating temp

- -35°C to +75°C (-31°F to +167°F) / -35°C Cold start-up

Storage temp

- -45°C to +85°C (-49°F to +185°F)

Dimensional line drawing

All measurements are in millimeters

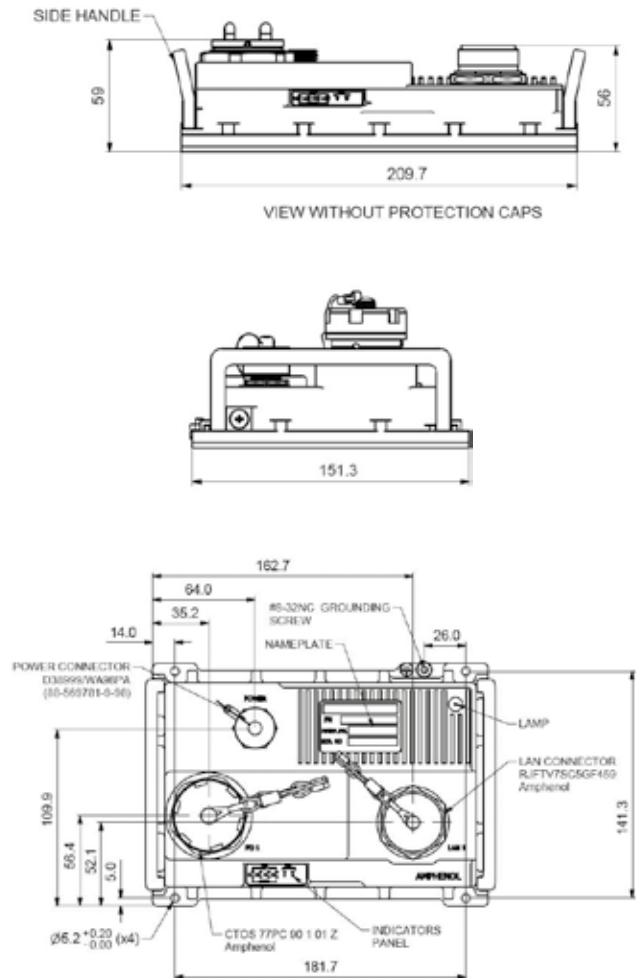

		Description
Part number	RES-GMC-1M-RJF-CTOS	<ul style="list-style-type: none"> • MIL-STD Rugged Ethernet Media Converter with CTOS fiber connector • 1 x 10/100/1000TX to 1000SX, MM
	RES-GMC-1S-RJF-CTOS	<ul style="list-style-type: none"> • MIL-STD Rugged Ethernet Media Converter with CTOS fiber connector • 1 x 10/100/1000TX to 1000LX, SM, 10 KM
	RES-GMC-1M-RJF-TACBEAM	<ul style="list-style-type: none"> • MIL-STD Rugged Ethernet Media Converter with TAC BEAM fiber connector • 2 x 10/100/1000TX to 2 x 1000SX, MM
	RES-GMC-1S-RJF-TACBEAM	<ul style="list-style-type: none"> • MIL-STD Rugged Ethernet Media Converter with TAC BEAM fiber connector • 2 x 10/100/1000TX to 2 x 1000LX, SM, 10 KM

► For accessories, please consult us.

RES-GMC-1M-FORC

Military Ethernet Media Converter with Remote Control

For Fiber Extension of Existing Systems on the Field

Amphenol's RES-GMC-1M-FORC is a MIL-STD rugged, unmanaged-military-grade Media converter, offering one Gigabit copper ports 10/100/1000Base-TX and one 100/1000Base-SX fiber ports.

Combining the RES-GMC-1M-FORC with a fiber drum, your network will be extended on the field.

- Simply add 2 media converters unit 1 and unit 2 + a fiber drum
- Use our special feature: unit 2 is remote controlled by unit 1

Due to extreme low consumption of unit 2 in STANDBY mode, your battery on the field will operate longer.

Developed for military and harsh environment applications, the RES-GMC-1M-FORC features mechanical packaging enhancements designed for MIL-STD-810F airborne and ground environmental compliance and high reliability.

The unit has been especially hardened to improve ingress, impact, and shock/vibration protection, as well as eliminate all moving parts through passive cooling, and interface through sealed MIL-D-38999 circular connectors.

Leveraging best-in-class technology, the RES-GMC-1M-FORC series serves as a robust solution to extend your Tactical Gigabit Ethernet network connectivity over fiber.

Military applications

- Data acquisition & transmission
- Battlefield communication C4ISR
- Rugged Networks
- Combat vehicles

Where your system can be extended through network.



Unit 1



Fiber drum



Unit 2

Key features

- **Ethernet ports**
 - 10/100/1000 Base TX to 100/1000 Base SX-(MM) Media converter
- **Networking**
 - Full wire-speed forwarding rate
 - Store-and-forward or Pass through mechanism
 - Auto MDI-II, MDI-X, FDX, HDX, Flow control
 - Auto-negotiation and fixed settings via DIP switch
 - Jumbo frame support
 - Link loss forwarding mechanism
- **Connectors**
 - MIL-D-38999 (Power & Ethernet signals)
 - Fiber connector type: CTOS 77 PC (2 fibers for Ethernet, 1 fiber for remote control)
 - Protective caps over each connector
- **Chassis**
 - Low profile rugged aluminium extrusion
 - Conductively cooled w/custom internal heat-sinks
 - Ingress protection against sand, dust and moisture
 - Anodize coating, MIL-A-8625, Type II, Class 2
 - Color: sand mate
- **Standards**
 - MIL-STD-1275, MIL-STD-704A, MIL-STD-461E,
 - MIL-STD-810F GM, IP67/68

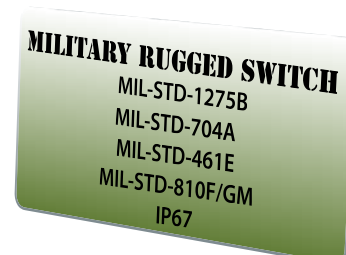

Product specifications

■ Performance

- 26.8 Mpps wire speed forwarding rate
- 2 Gbps maximum forwarding bandwidth
- 4K MAC address
- 2 LED indication (Speed, Link/Activity) per port
- Wire-speed reception and transmission

■ Standards compliance

- IEEE 802.3, 10 Mbps 10BASE-T (Ethernet)
- IEEE 802.3u, 100 BASE-TX 100 Mbps (Fast Ethernet)
- IEEE 802.3ab, 1000Base-TX
- IEEE 802.3z, 1000Base-FX Gigabit
- IEEE 802.3x Flow control

■ Power

- MIL-STD-1275B & MIL-STD-704A Surge and Spike protection
- Voltage input: 24Vdc nominal (18-36V)
- Power switching of the external DC input of unit 2 upon ON/OFF command from unit 1
- Maximum power consumption: 5W for unit 1, 10W for unit 2
- Standby consumption of unit 2: <0.1W
- Chassis grounding

■ Electromagnetic

- MIL-STD-461E Electromagnetic compatibility

■ Environmental : shock/vibration/humidity

- MIL-STD-810F, 501.4I, 501.4II, 502.4I, 502.4II, 507.4, 500.4II, 514, 516I, 516VI, 514.5, 512.4
- IP67/68

■ Physical

- Dimensions: 170mm(L) x 140(W) x 110(H), including connectors & hardware
- Weight: 1.55kg for unit 1, 1.80kg for unit 2

■ Installation

- Set of Four 4x4.3 mounting holes on bottom for mounting to any flat surface.

■ Cooling

- No moving parts. Passive cooling.

■ Operating temp

- -35°C to +75°C (-31°F to +167°F) / -35°C Cold start-up

■ Storage temp

- -45°C to +85°C (-49°F to +185°F)

Dimensional line drawing

All measurements are in millimeters

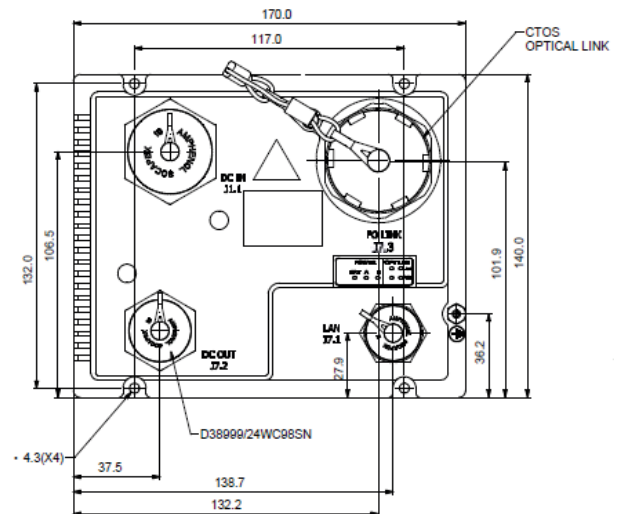
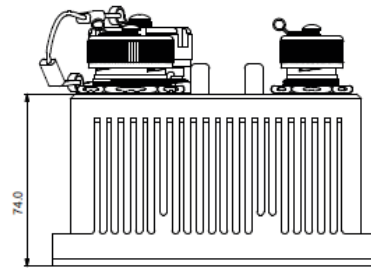
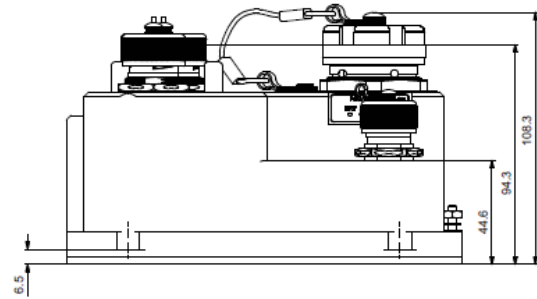

		Description
Part number	RES-GMC-1M-FORC-1	MIL-STD Rugged Gigabit Media Converter unit 1, 1x RJF connector, 1x fiber CTOS connector, MM, SX
	RES-GMC-1M-FORC-2	MIL-STD Rugged Gigabit Media Converter unit 2, 1x RJF connector, 1x fiber CTOS connector, MM, SX, remote controlled by unit 1
	CTOS drum	Please consult us

► For accessories, please consult us.

NOTES

A series of horizontal dotted lines for writing notes, spanning the width of the page.

NOTES

A series of horizontal dotted lines for writing notes.

ABOUT AMPHENOL

Founded in 1932, **Amphenol** is one of the largest manufacturers of interconnect products in the world. The company designs, manufactures, and markets electrical, electronic, and fiber optic connectors, interconnect systems, and coaxial and specialty cables.

Amphenol has a diversified presence as a leader in high growth areas of the interconnect industry and provides solutions for customers in the automotive, broadband, industrial, information technology and data communications, military and aerospace, mobile devices, and mobile networks markets.

More info on www.amphenol.com



Amphenol Military & Aerospace Operations (AMAO) has the largest and broadest selection of interconnect products in the military and aerospace markets.

More info on www.amphenolmao.com



Europe

FRANCE	Amphenol AIR LB	2 rue Clément Ader, ZAC de Wé - 08110 Carignan	+33 3 24 22 78 49
FRANCE	Amphenol SEFEE	Z.I. des Cazes – BP243 - 12402 Saint-Affrique Cedex	+33 5 65 98 11 00
GERMANY	Amphenol AIR LB GMBH	Am Kleinbahnhof 4 - 66740 Saarlouis	+49 6831 981 00
ITALY	Amphenol EUROPEAN SALES OPERATIONS	Via Barbaiana n.5 - 20020 Lainate - Milano	+39 293 254 214
UNITED KINGDOM	Amphenol INVOTEC	Unit 1-3, Hedging Lane Industrial Estate, Dosthill - Tamworth, B77 5HH	+44 1827 263 000
UNITED KINGDOM	Amphenol IONIX SYSTEMS	Prospect House, Taylor Business Park, Risley, Warrington, WA3 6HP	+44 1 942 685 200
UNITED KINGDOM	Amphenol LTD	Thanet Way, Whitstable - KENT, CT53JF	+44 1227 773 200
UNITED KINGDOM	Amphenol MARTEC	St Augustines Business Park, Swalecliffe Whitstable - Kent CT5 2QJ	+44 1227 793 733

North America

CANADA	Amphenol CANADA	605 Milner avenue - Toronto, Ontario	+1 416 291 0647
USA	Amphenol AEROSPACE OPERATIONS	40-60 Delaware street - Sidney, NY 13838	+1 800 678 0141
USA	Amphenol BORISH TECHNOLOGIES	4511 East Paris AVE - Grand Rapids, MI 49512	+1 616 554 9820
USA	Amphenol FSI	1300 Central Expwy N, Suite 100 - Allen, TX 75013	+1 214 547 2400
USA	Amphenol GRIFFITH ENTERPRISES	6000 East Coury Drive - Cottonwood, AZ 86326	+1 928 634 3685
USA	Amphenol NEXUS TECHNOLOGIES	50 Sunnyside Avenue - Stamford, CT 06902	+1 203 327 7300
USA	Amphenol PCD	72 Cherry Hill Drive - Beverly, MA. 01915	+1 978 624 3400
USA	Amphenol PRINTED CIRCUIT	Board Technology, 91 Northeastern Boulevard - Nashua, NH 03062	+1 603 324 4500
USA	Amphenol SV MICROWAVE	2400 Centrepark West Drive - West Palm Beach, FL	+1 561 840 1800
USA	Amphenol TIMES MICROWAVE	358 Hall Avenue - Wallingford, CT 06492	+1 800 867 2629

Asia

CHINA	Amphenol PCD CO.	Building 21, 1 st Liao Keng Industrial Zone, Shi Yan Street - BaoAn District - Shenzhen 518108	+86 755 8173 8000/8286
INDIA	Amphenol INTERCONNECT INDIA	105 Bhosari Industrial Area - Pune 411 026	+91 20 27120363
JAPAN	Amphenol JAPAN	471-1, Deba, Ritto-City - Shiga 520 3041	+81 77 553 8501
KOREA	Amphenol DAESHIN	558 SongNae-Dong SoSa-Gu, Bucheon-city, Kyunggi-Do - 420-130	+81 32 610 3830/3845
SINGAPORE	Amphenol EAST ASIA	26/F, Railway Plaza, 39 Chatham Road South, Tsim Sha Tsui, Kowloon, Hong Kong	+65 6294 2128

Other Areas

AFRICA	Amphenol AFRICA	30 Impala Rd - Sandton 2146	+27 82 410 5179
ARGENTINA	Amphenol ARGENTINA	Av. Callao 930 2do piso Oficina B "Plaza" C1023 - AAP Buenos Aires	+54 11 4815 6886
AUSTRALIA	Amphenol AUSTRALIA PTY	2 Fiveways Blvd., Keysborough - Melbourne - Victoria 3173	+61 3 8796 8888
BRAZIL	Amphenol DO BRAZIL	Rua Diogo Moreira, 132, 20 andar, rooms 2001-2-3	+55 11 3815 1003
ISRAEL	Amphenol BAR-TEC	3 Hagavish Street, K fir-Barkan Bldg. East Industrial Zone - Kfar-Sava, 44102	+972 9 764 4100
MEXICO	Amphenol OPTIMIZE	Carretera Internacional Km 6.5, Col. Parque Industrial, Nogales, Sonora, C.P. 84094	+52 631 311 160
NEW ZEALAND	Amphenol PHITEK	Level 4, 2 Kingdon Street, Newmarket, Auckland 1023	+64 9 524 2984
RUSSIA	Amphenol RUSSIA	Yaroslavskaja Street 8 - 129164 Moscow	+7 495 937 6341
TURKEY	Amphenol TURKEY	Sun Plaza 15 Kat: 15 Maslak Hah. Bilim Sok. No.5 - Sisli/Istanbul, 34398	+90 212 367 92 19

Amphenol SOCAPEX



Amphenol Socapex

948, promenade de l'Arve BP29
74311 Thyez Cedex - France
Phone: +33 (0)4 50 89 28 00
contact@amphenol-socapex.fr
www.amphenol-socapex.com



For Technical Support

+33 (0)4 50 89 28 49
technicalsupport@amphenol-socapex.fr
www.amphenol-socapex.com/technical_support



To buy our products

+33 (0)4 50 90 28 00
contact@amphenol-socapex.fr
www.amphenol-socapex.com/amphenol/sales
Request a quote online at www.amphenol-socapex.com/quotation_request



Documentation

www.amphenol-socapex.com/documentation
To order a paper version of our catalogs, send an e-mail to communication@amphenol-socapex.fr



www.amphenol-socapex.com
Follow Amphenol Socapex on social media :



This catalog uses paper from managed forests, PEFC & FSC labels, and is printed by a printer certified "Imprim'Vert®"

We reserve the right to modify our products in any way we deem necessary.
Any duplication is prohibited, unless approved in writing.

Designed by Amphenol Socapex
DOC-000502-ANG - July 2017